

n

O

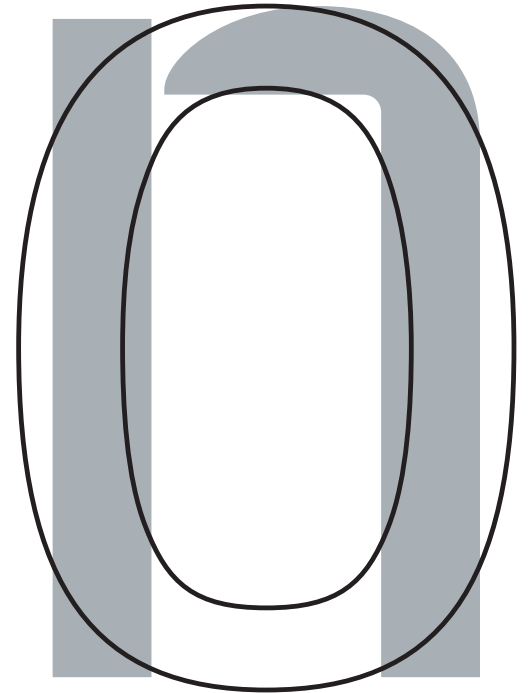

a

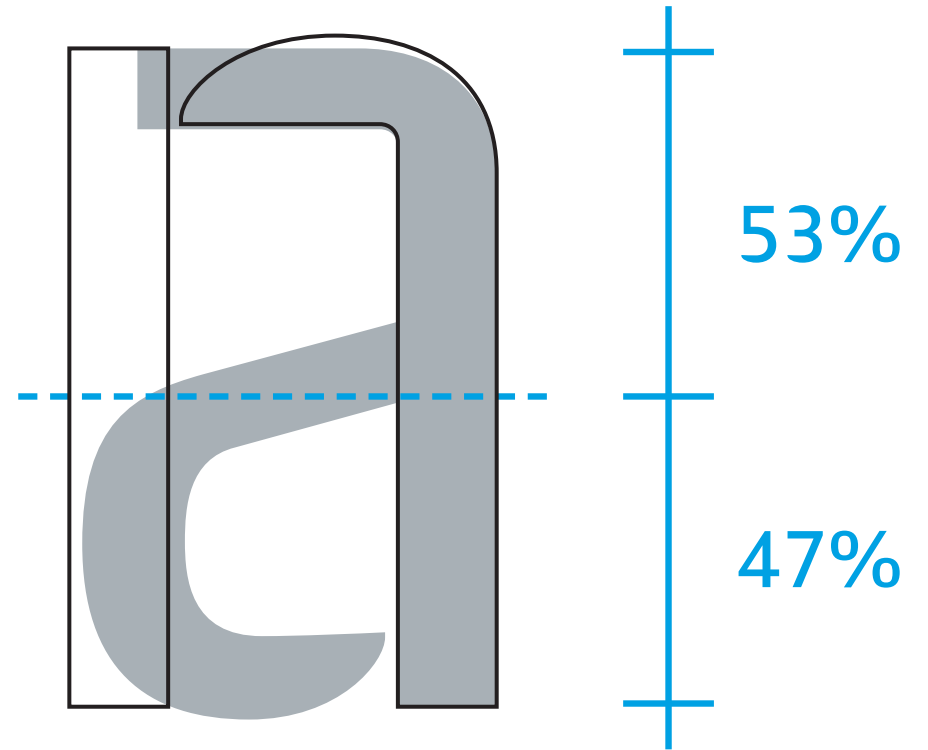

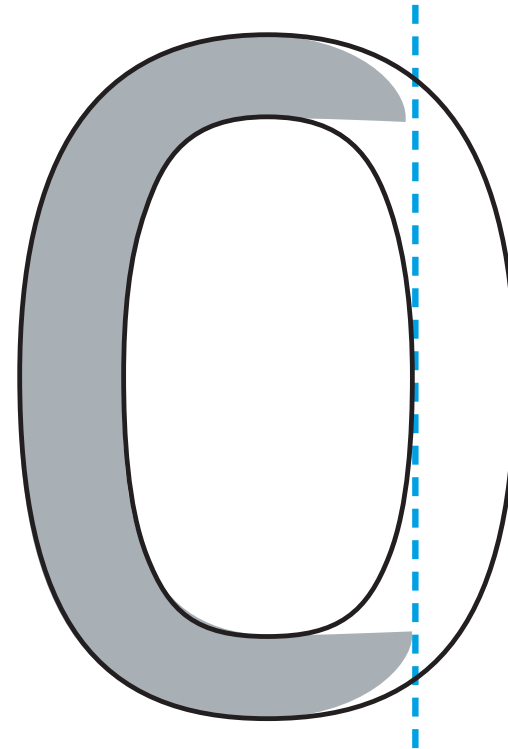

e

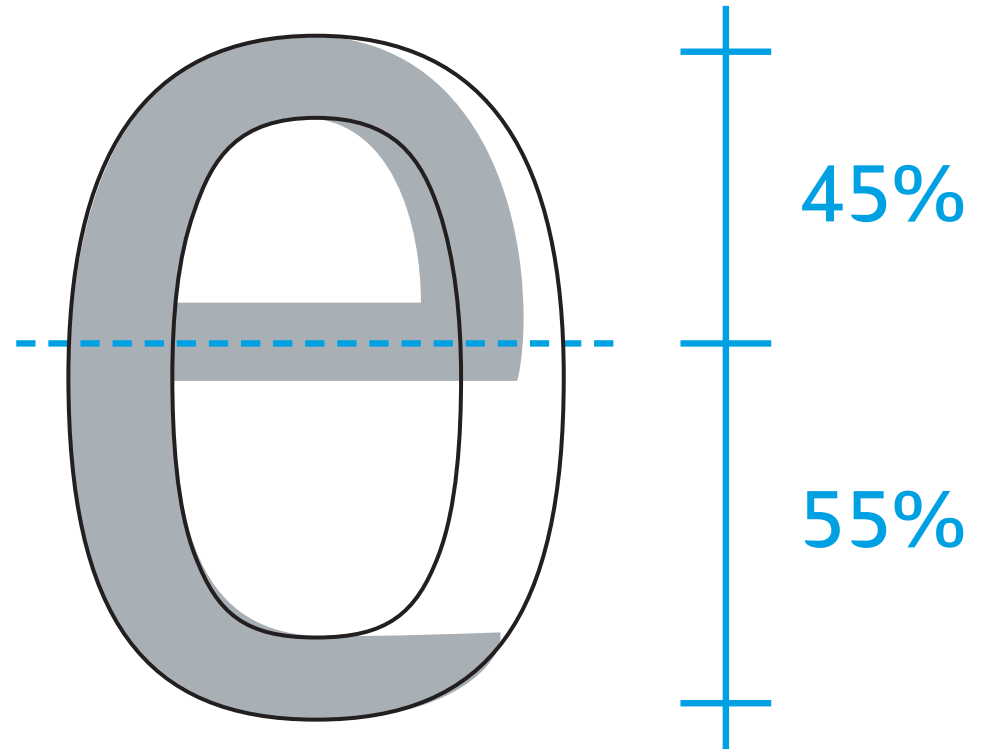

e

e

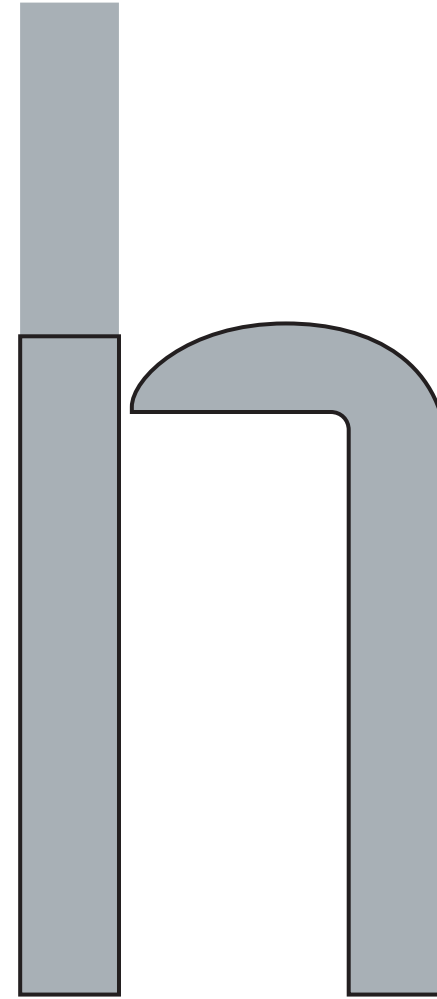

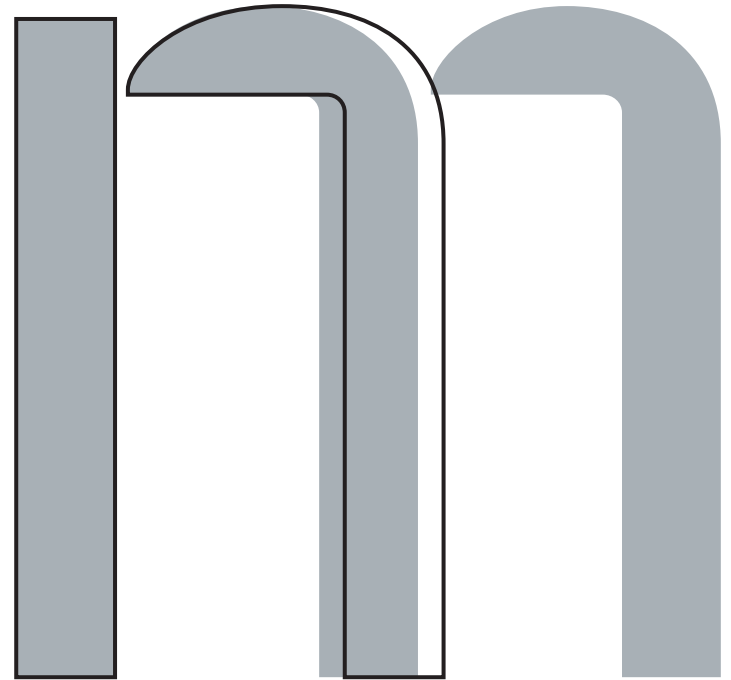

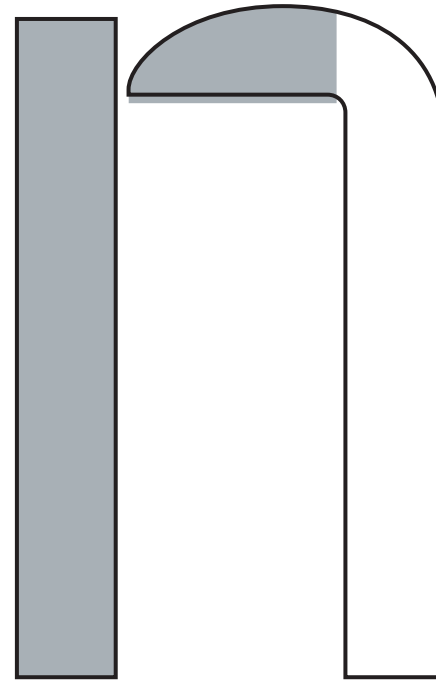



U

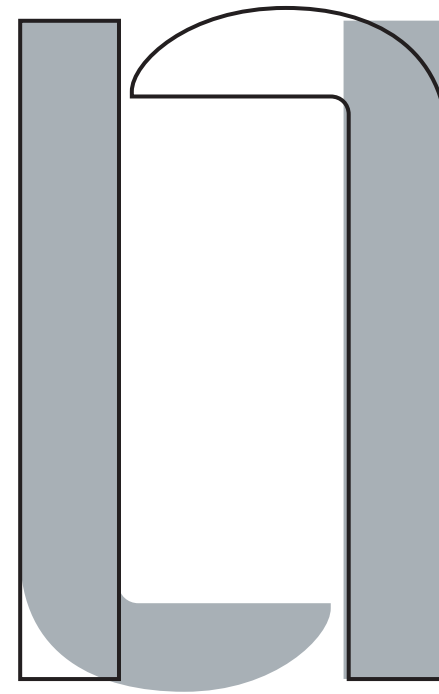

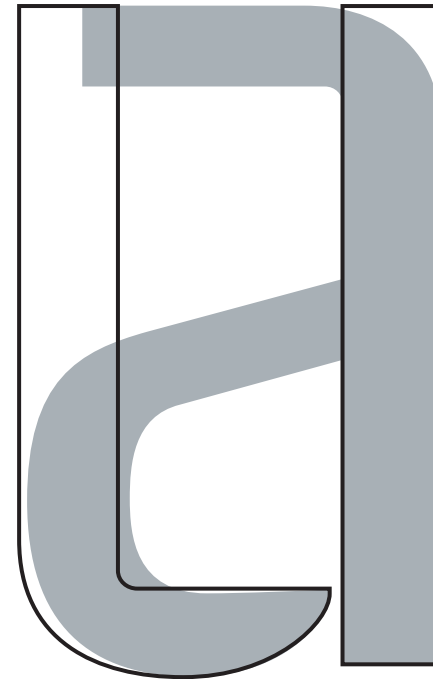
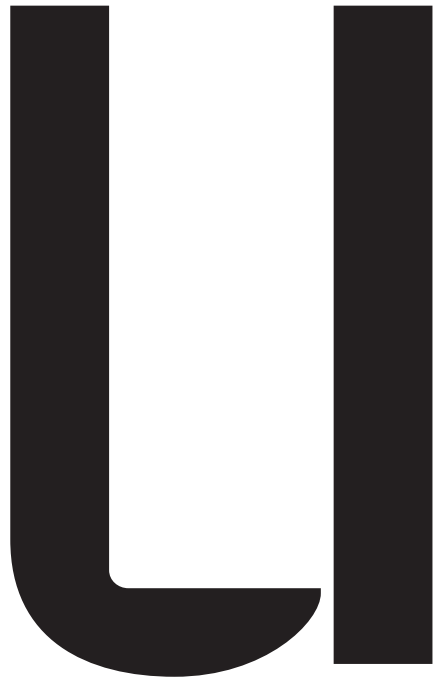

**b**

**b**

**b**

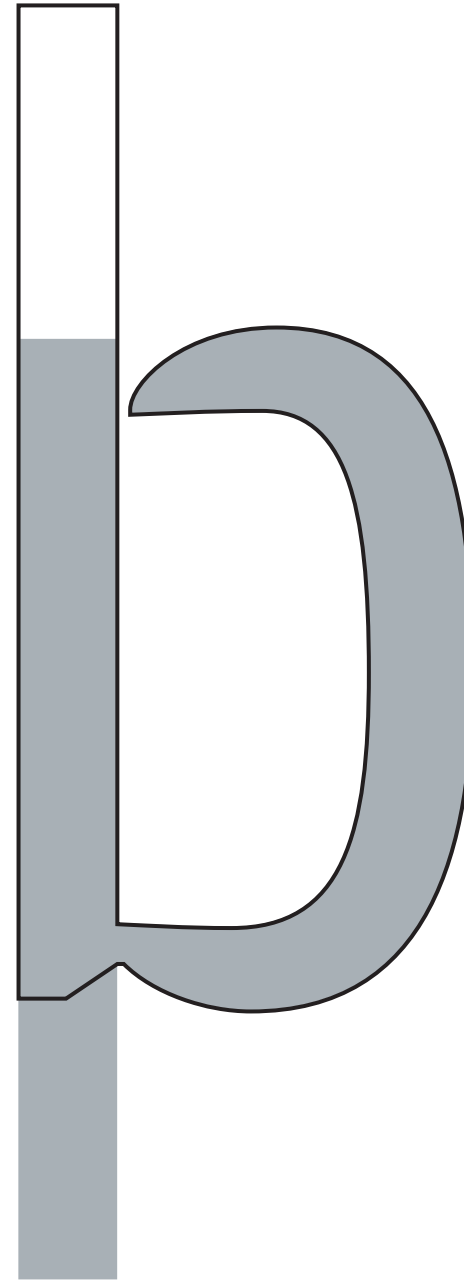

d

d

d

b rotated 180° →



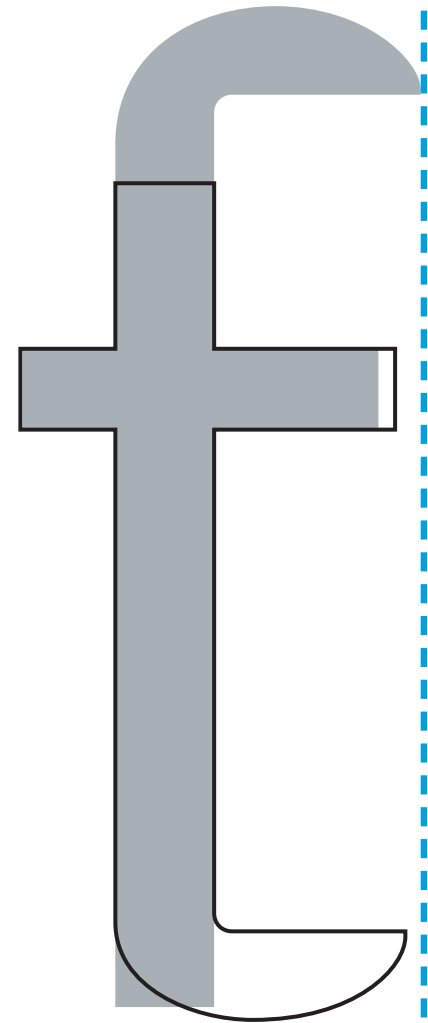

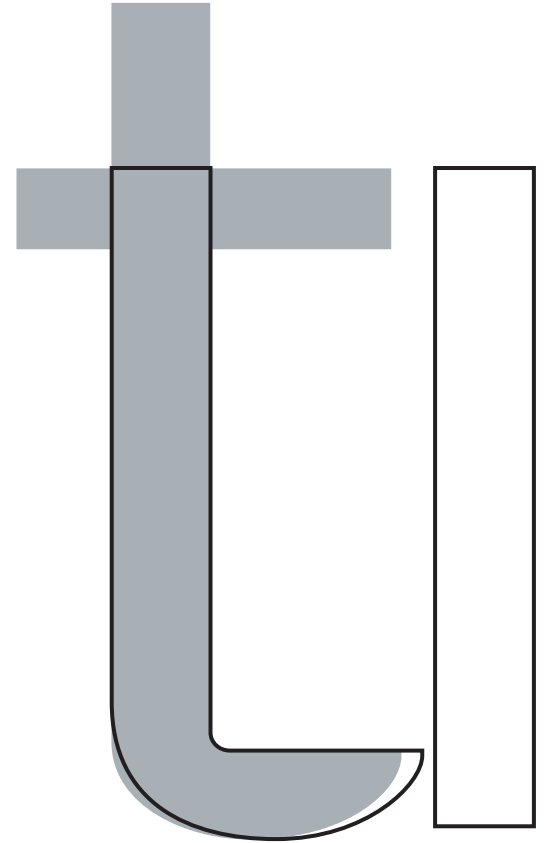
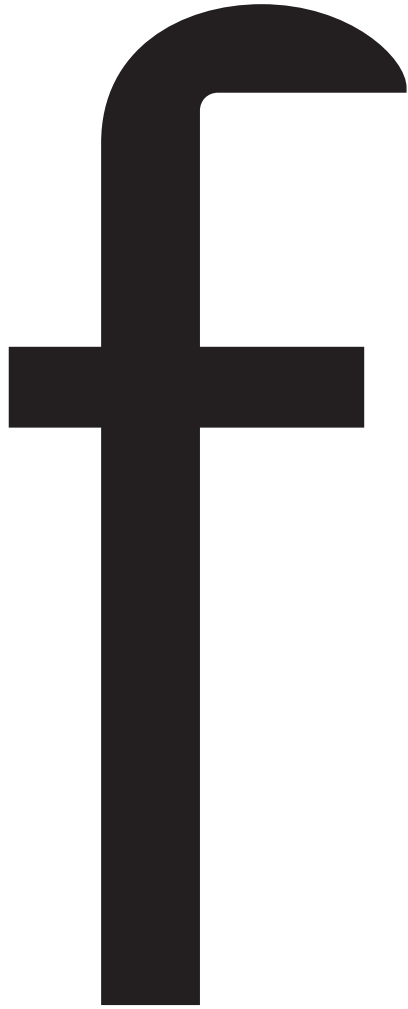





f rotated 180° →

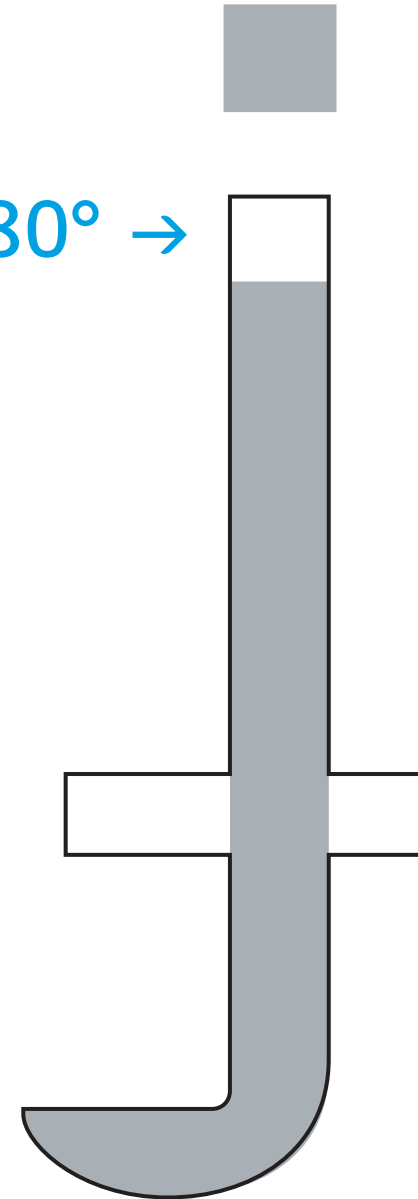

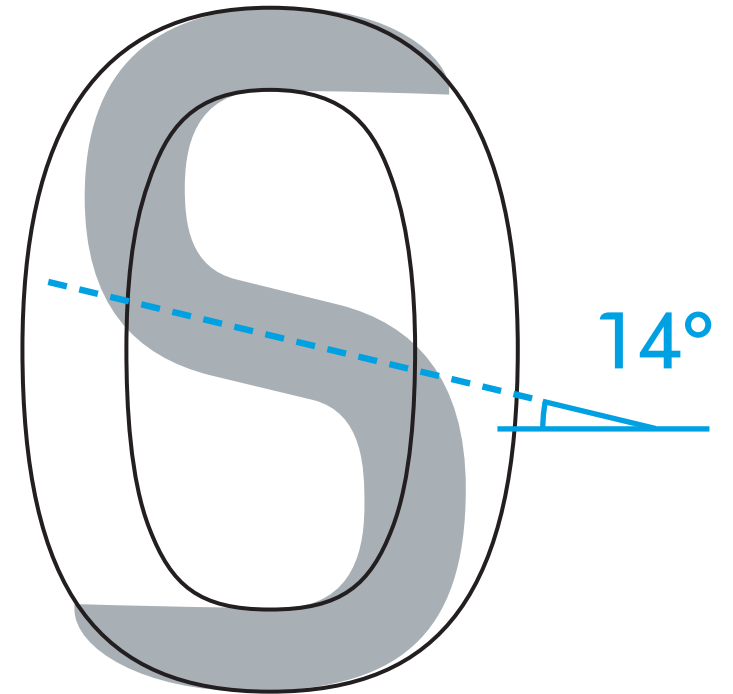
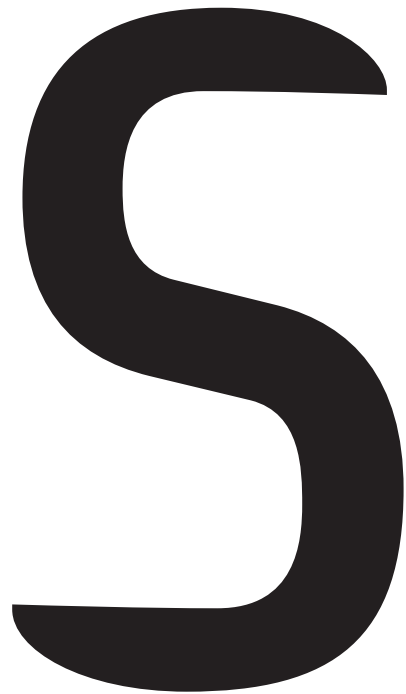

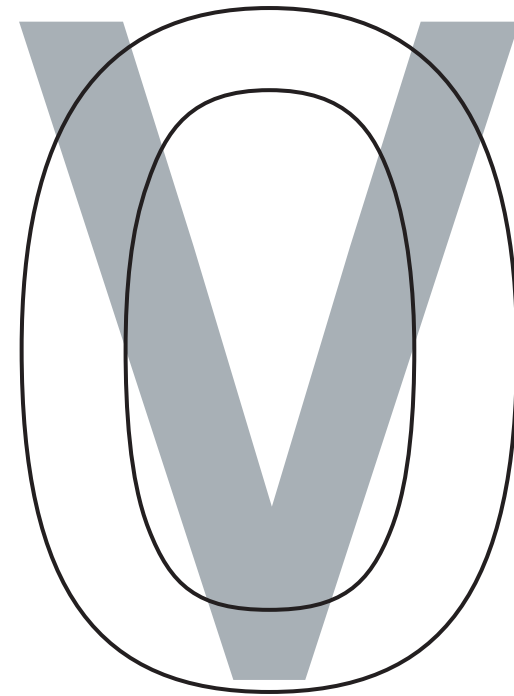

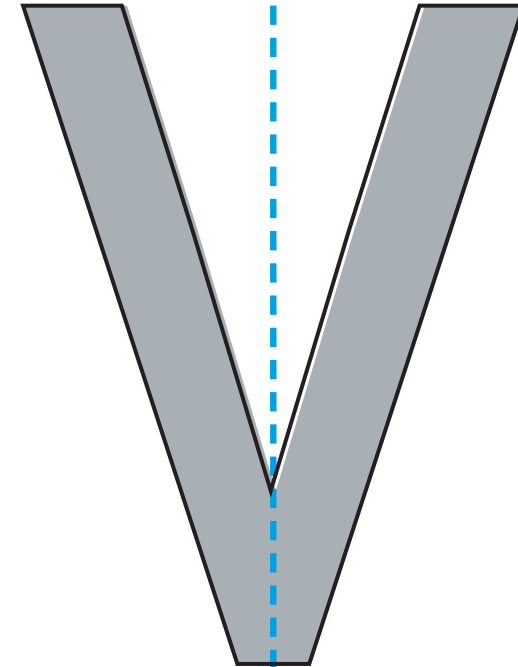

(outline) v ↑  
flipped horizontal

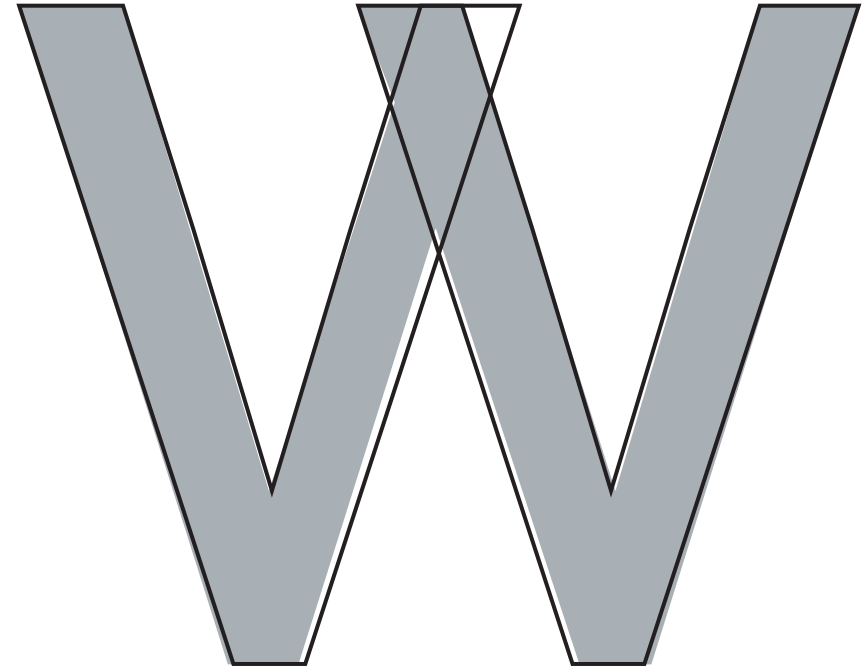

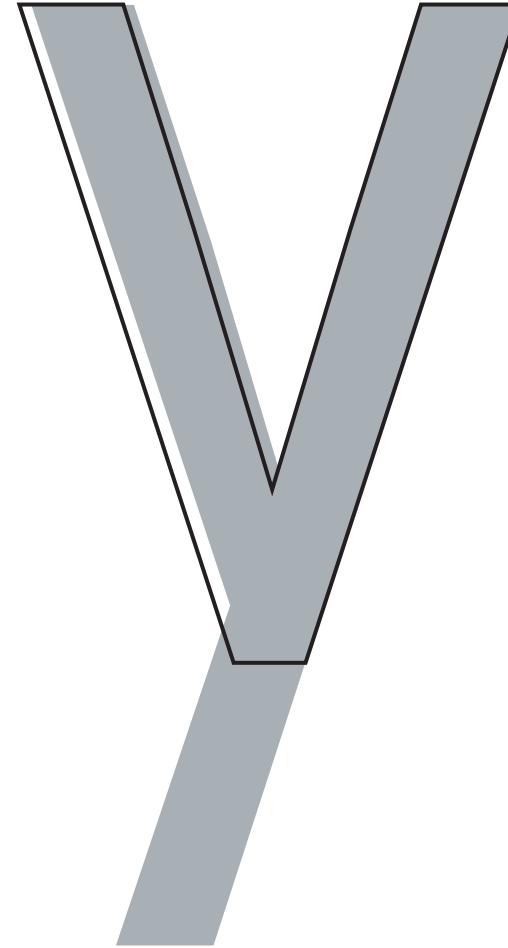
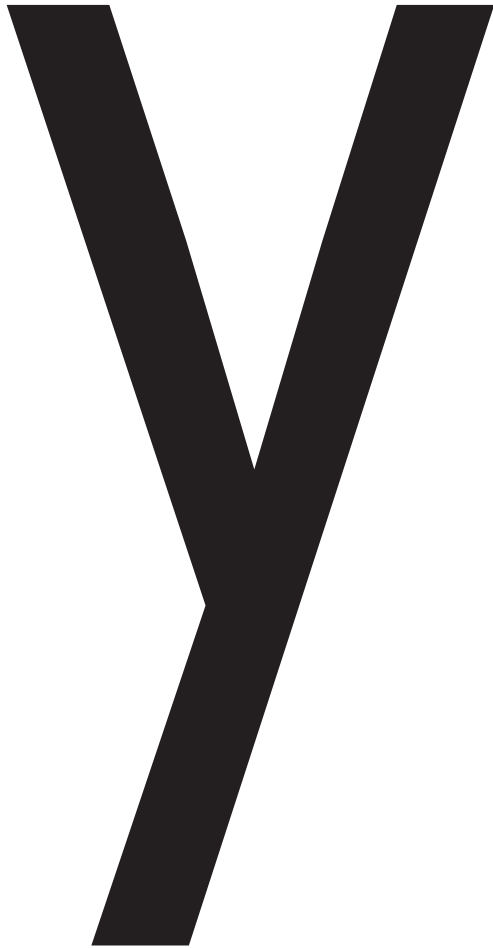

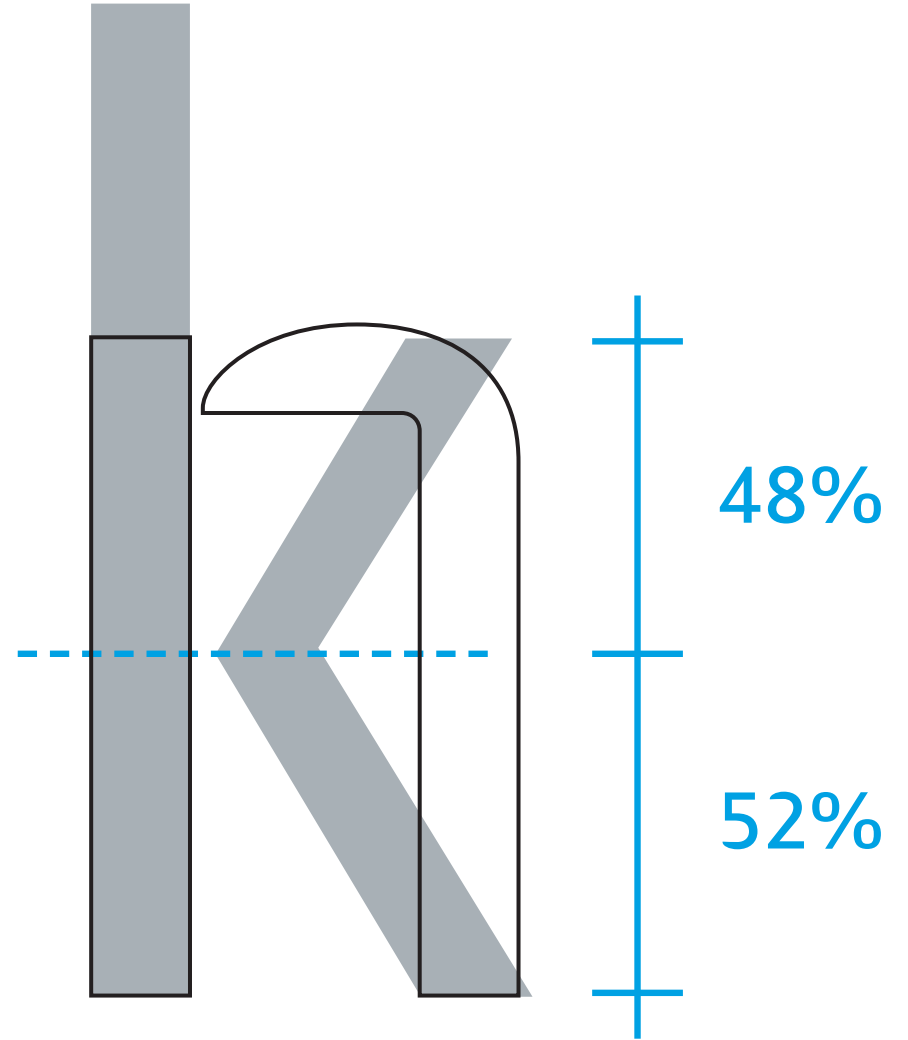

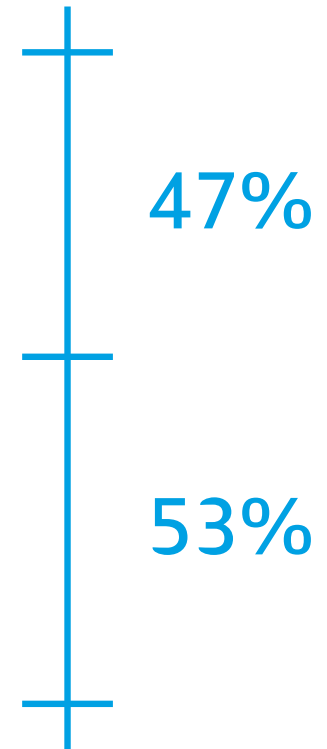
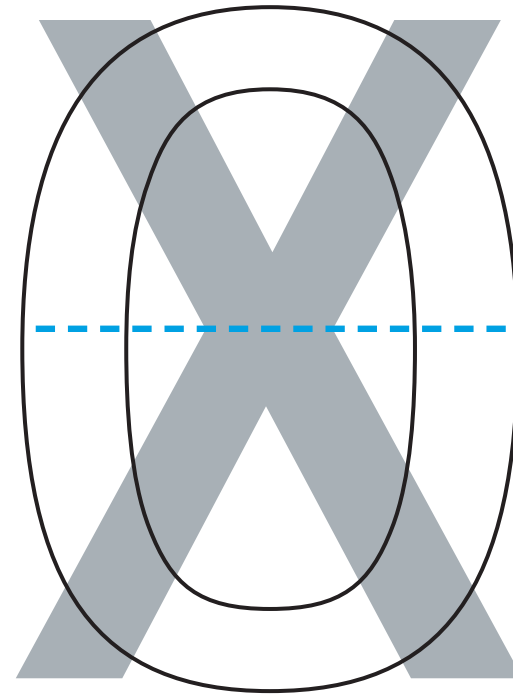



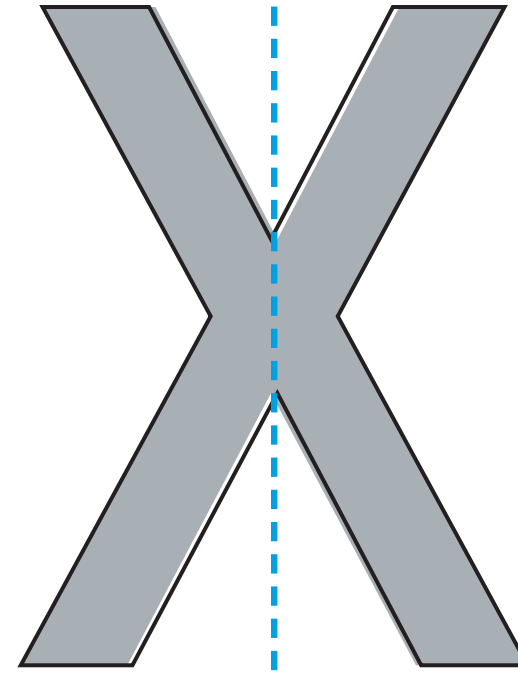

(outline) x ↑  
flipped horizontal

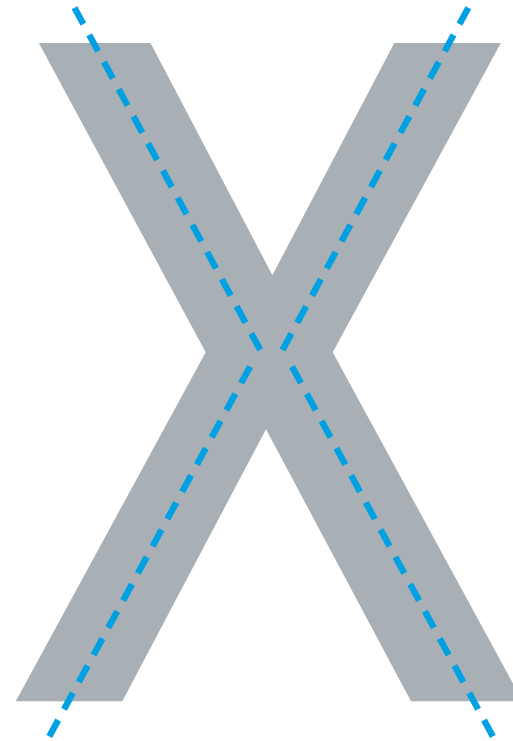

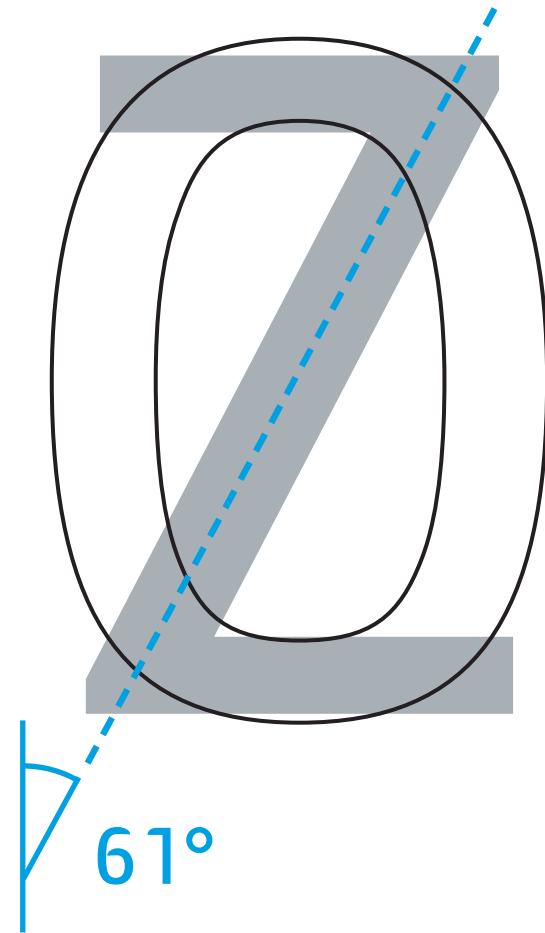

**H**

**O**

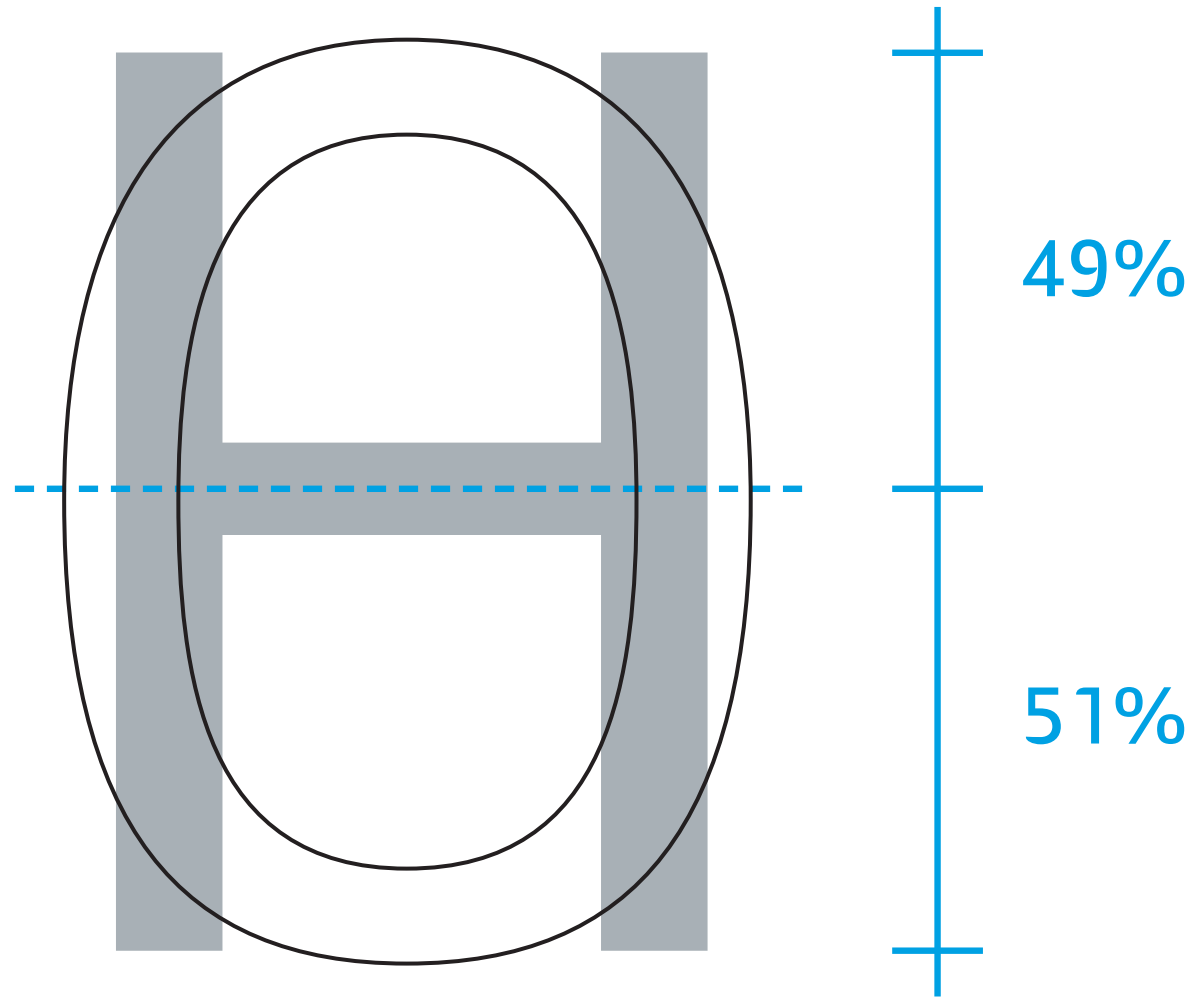

**B**

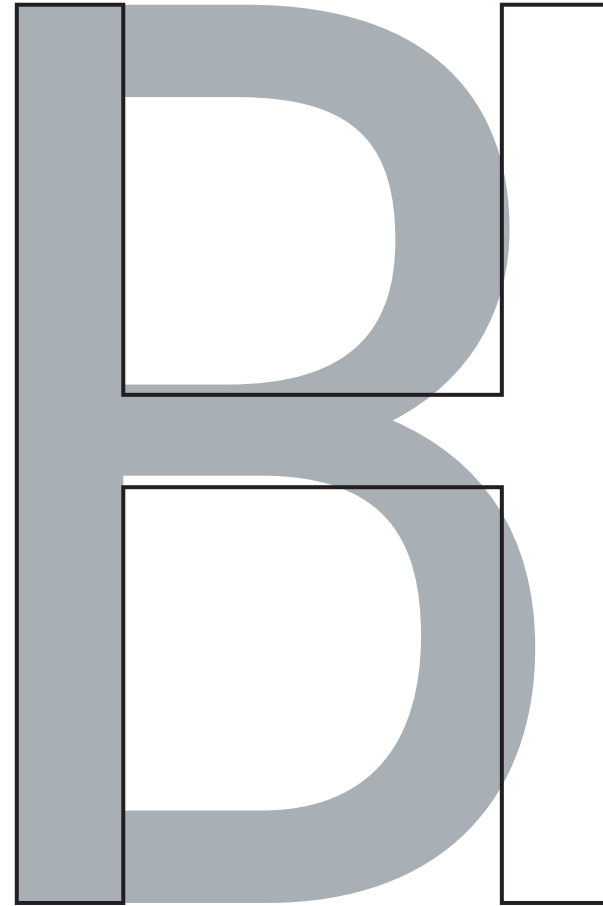

P

B

R

R



R

R

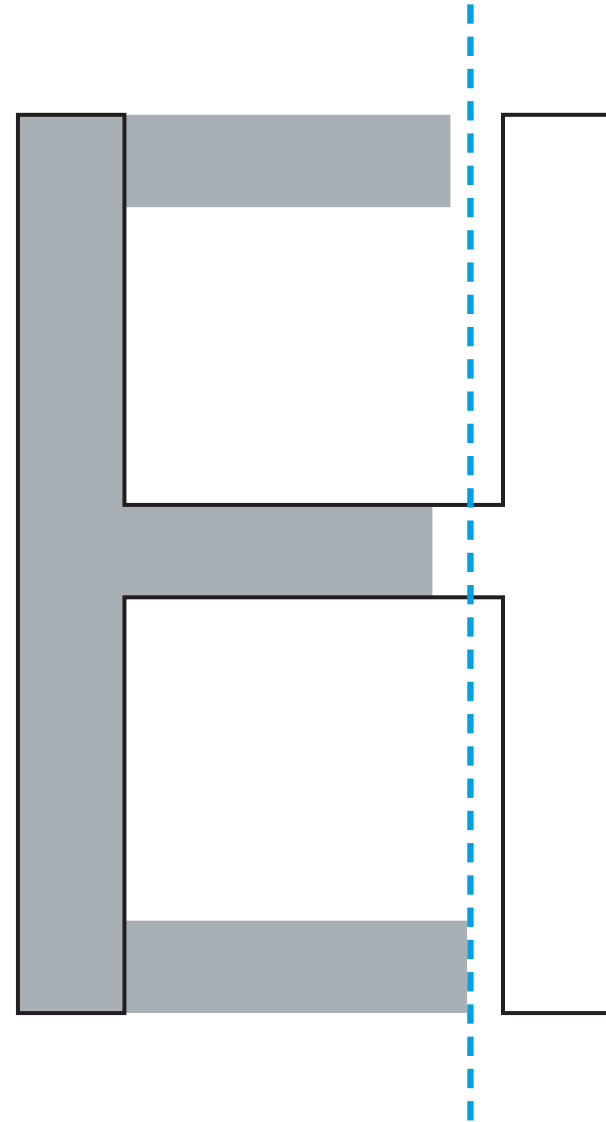

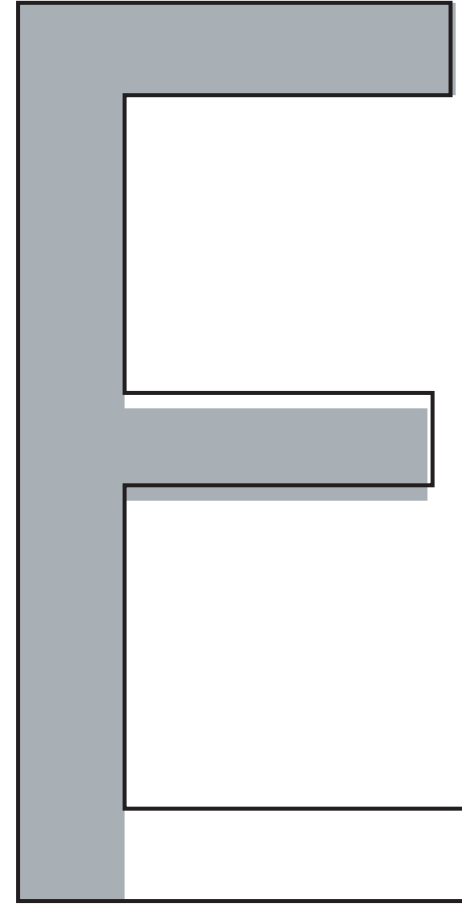

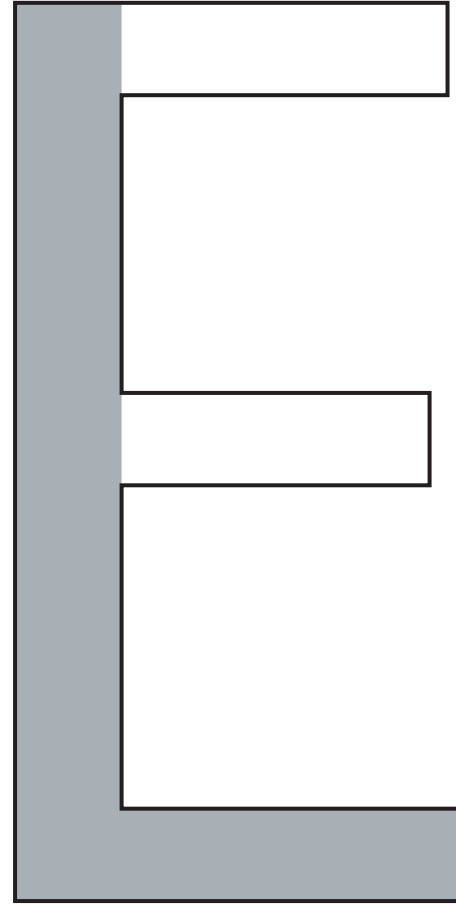

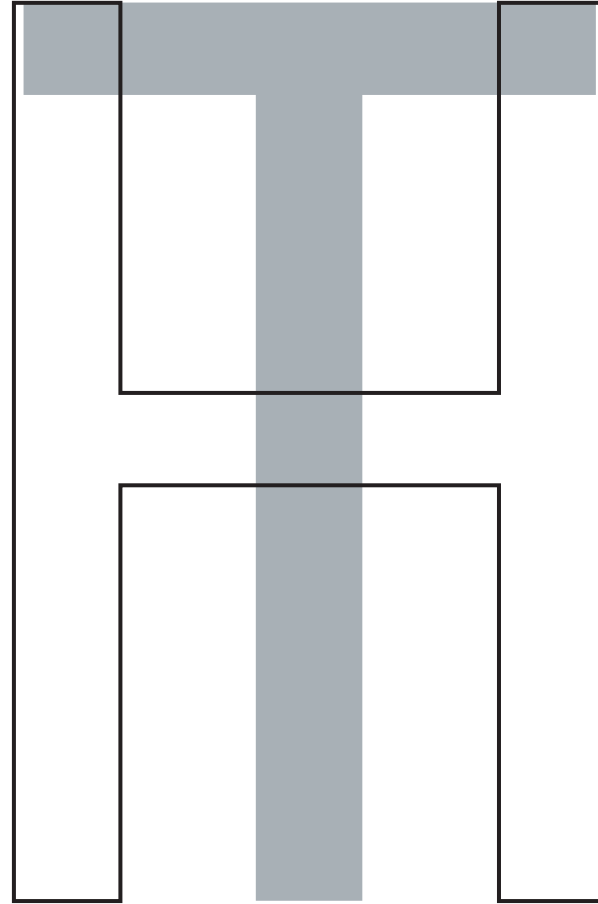

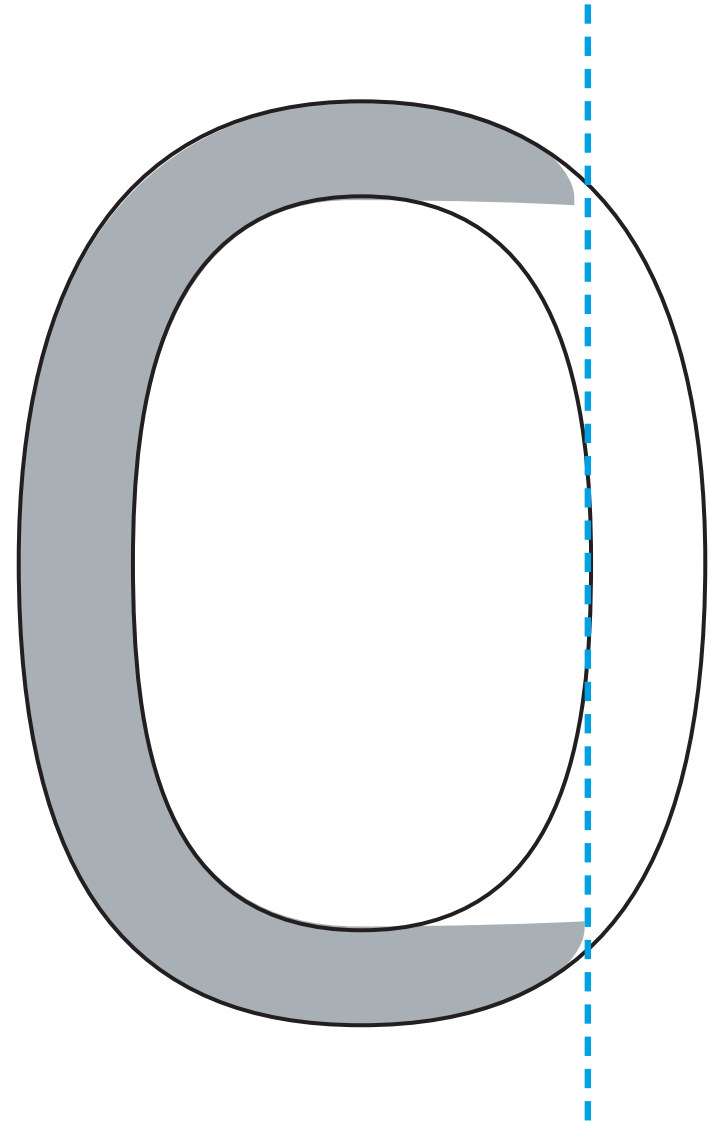

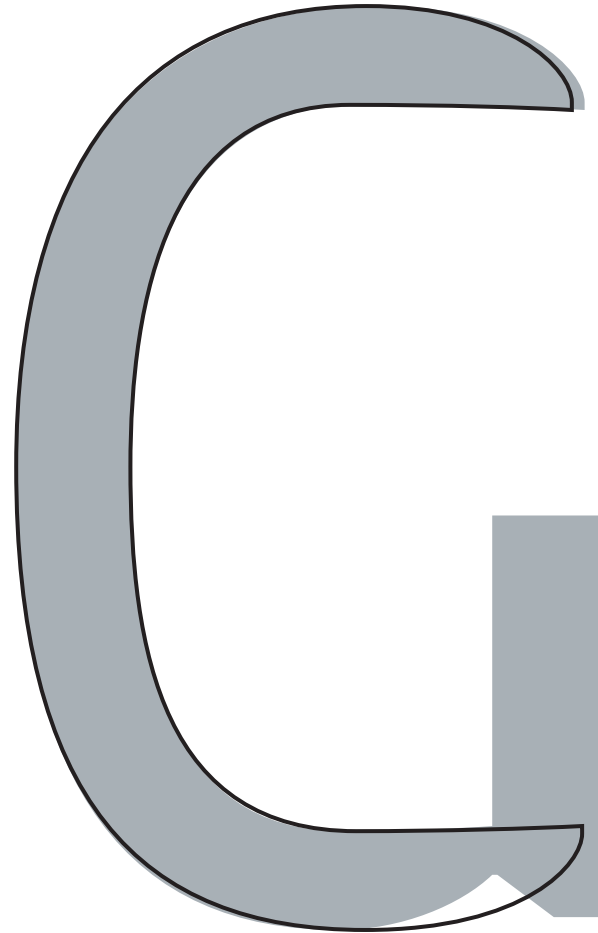

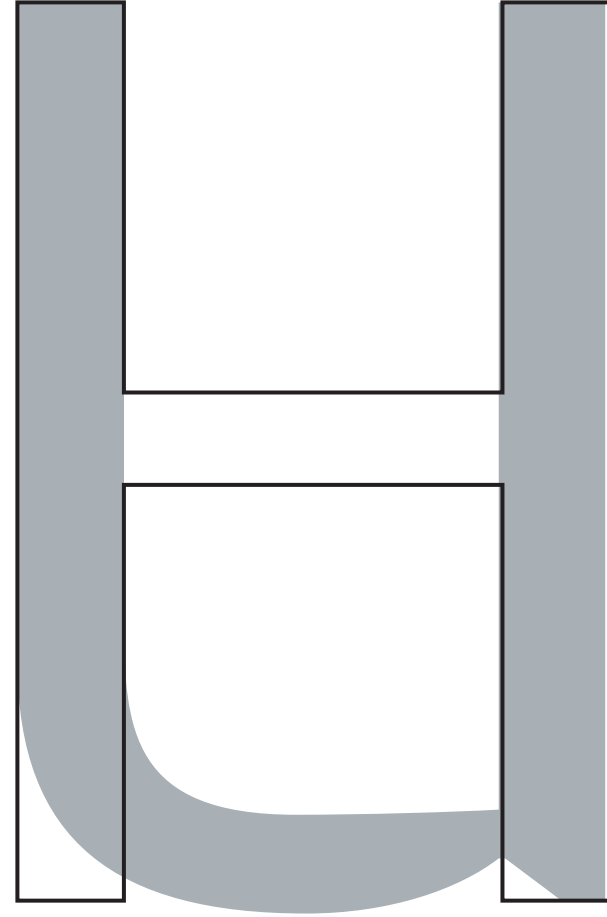



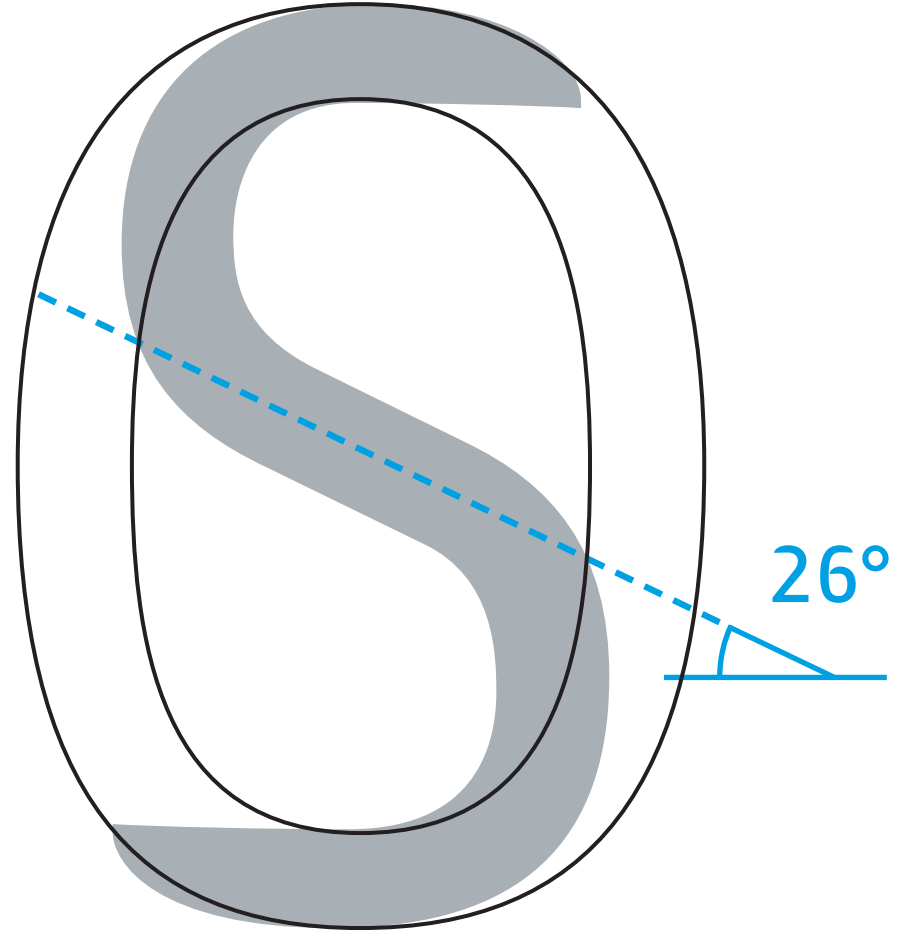
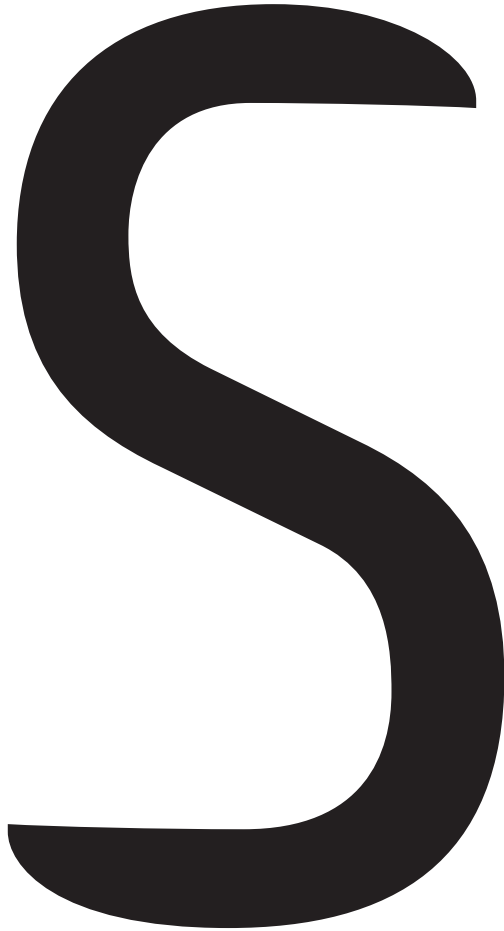

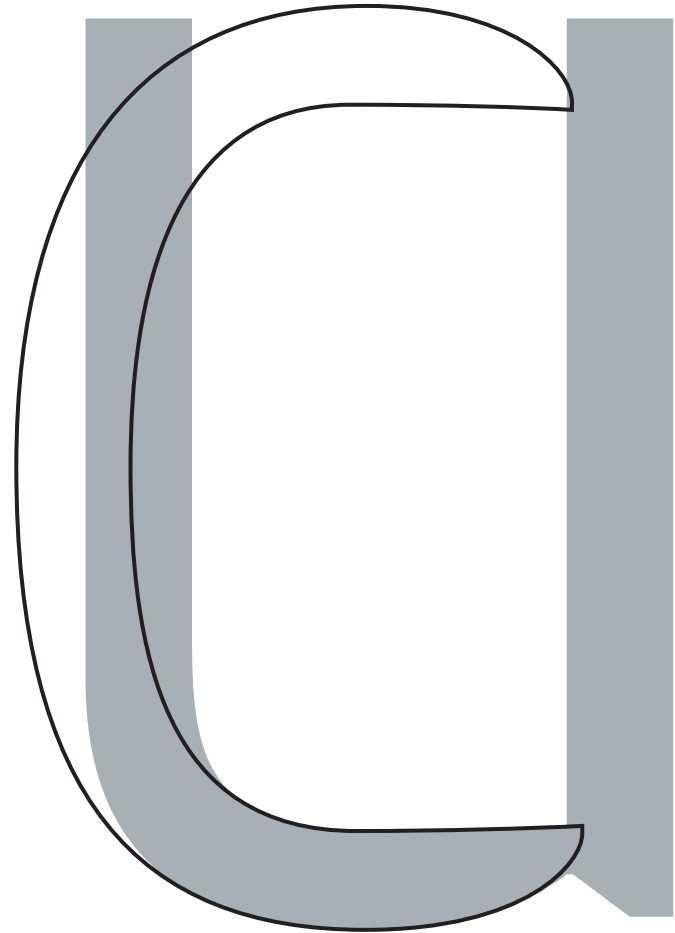
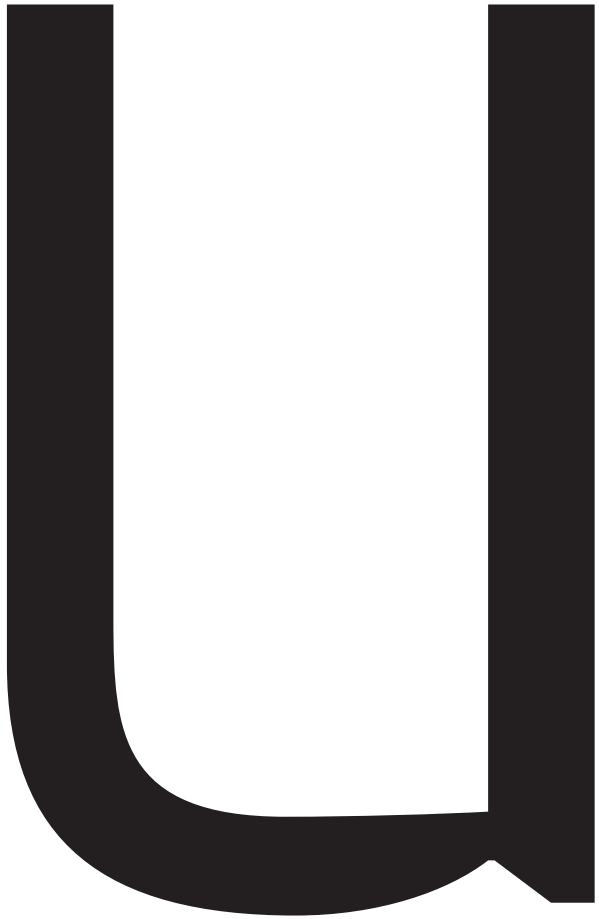

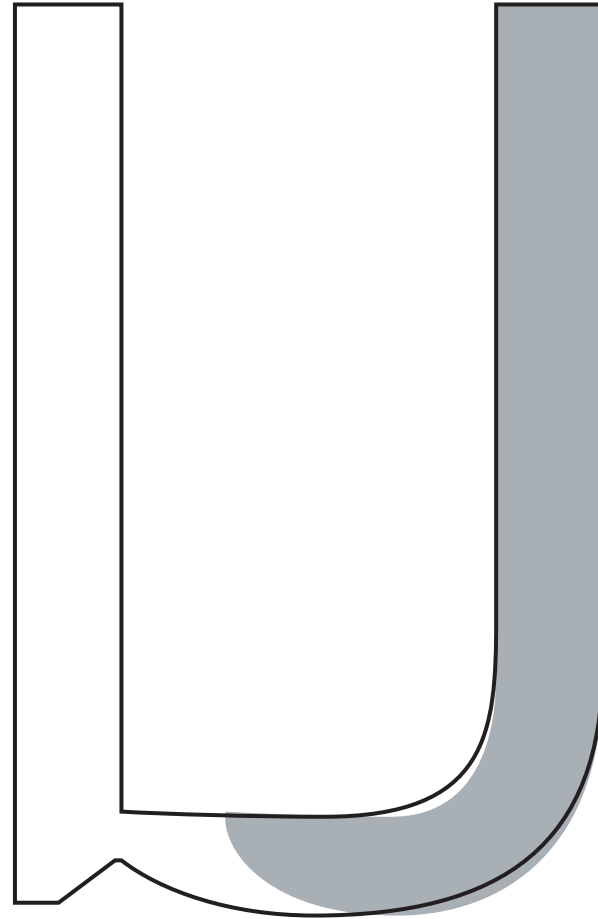

(outline) J ↑  
flipped horizontal

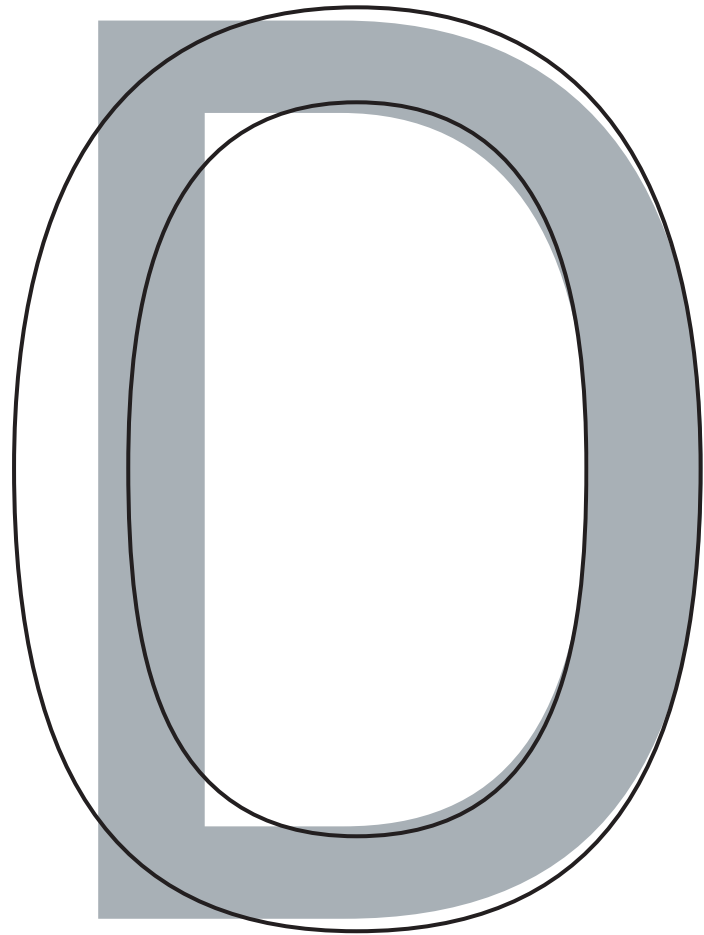

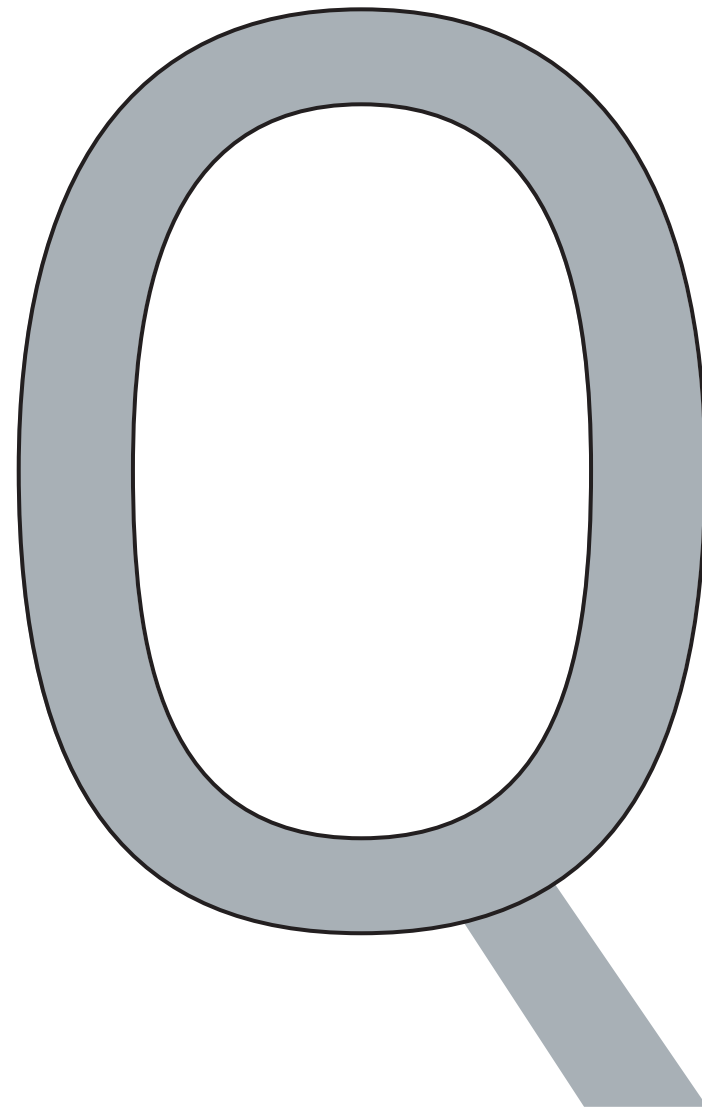
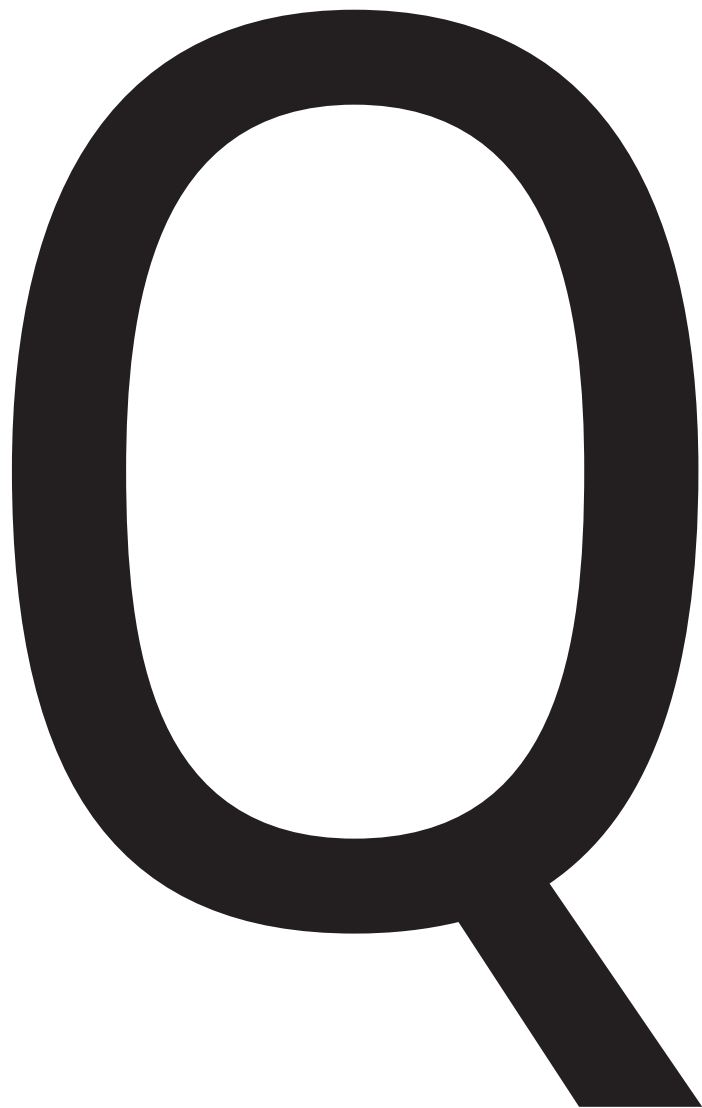

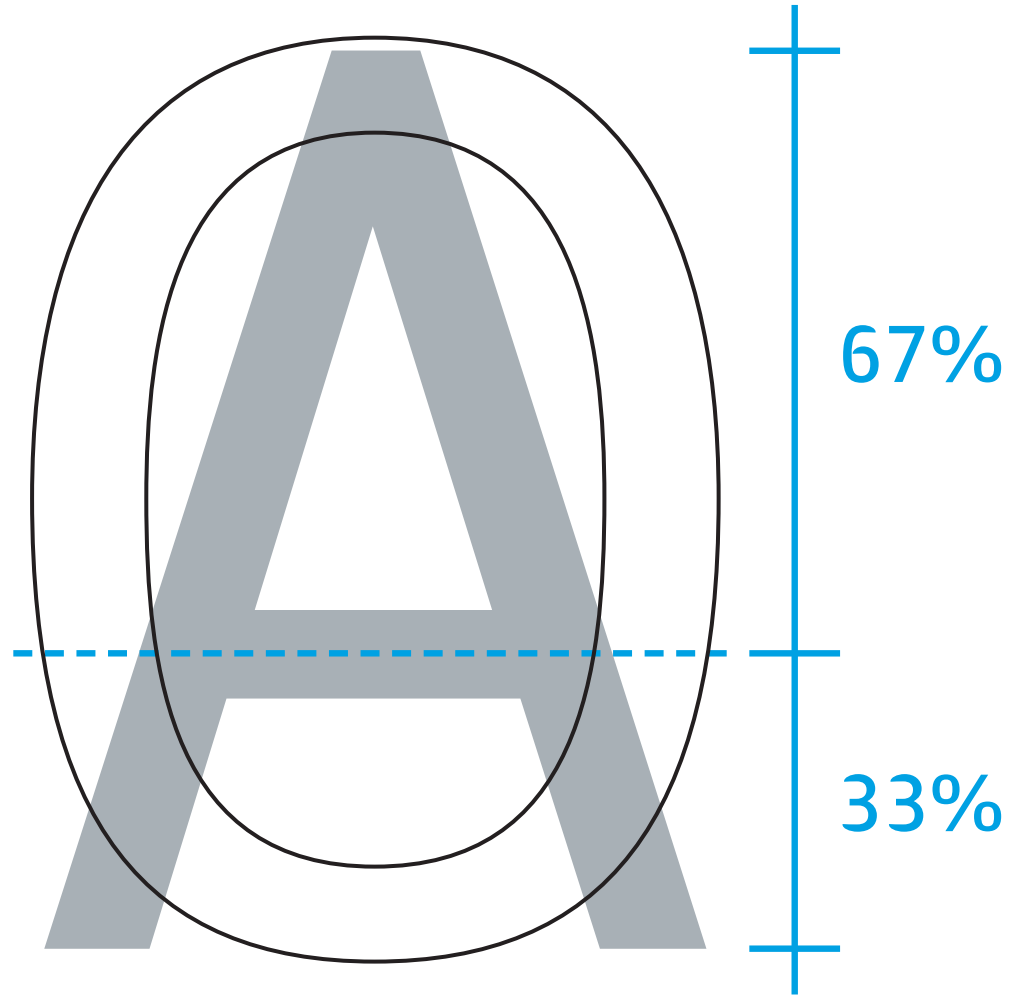
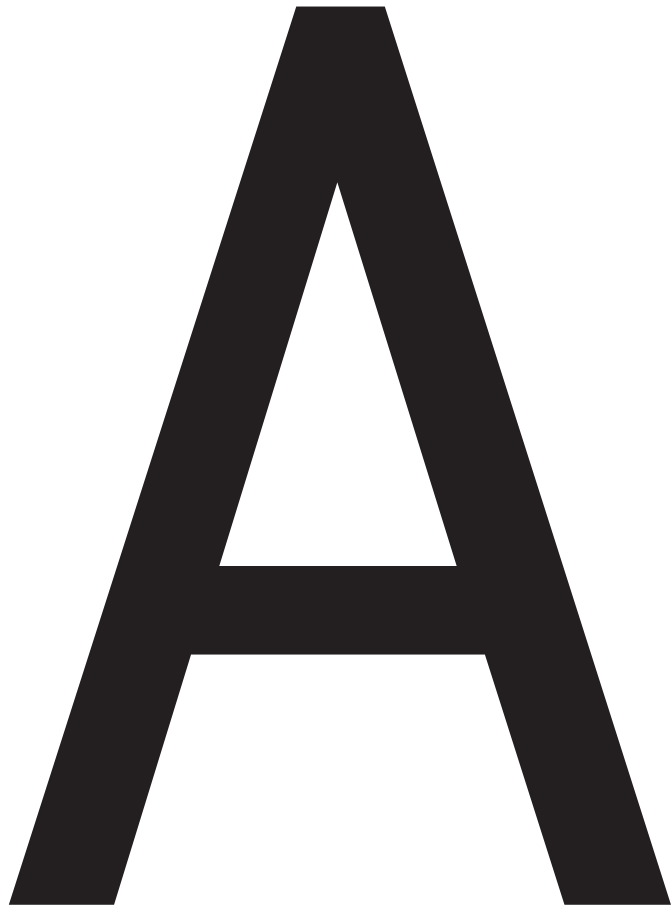

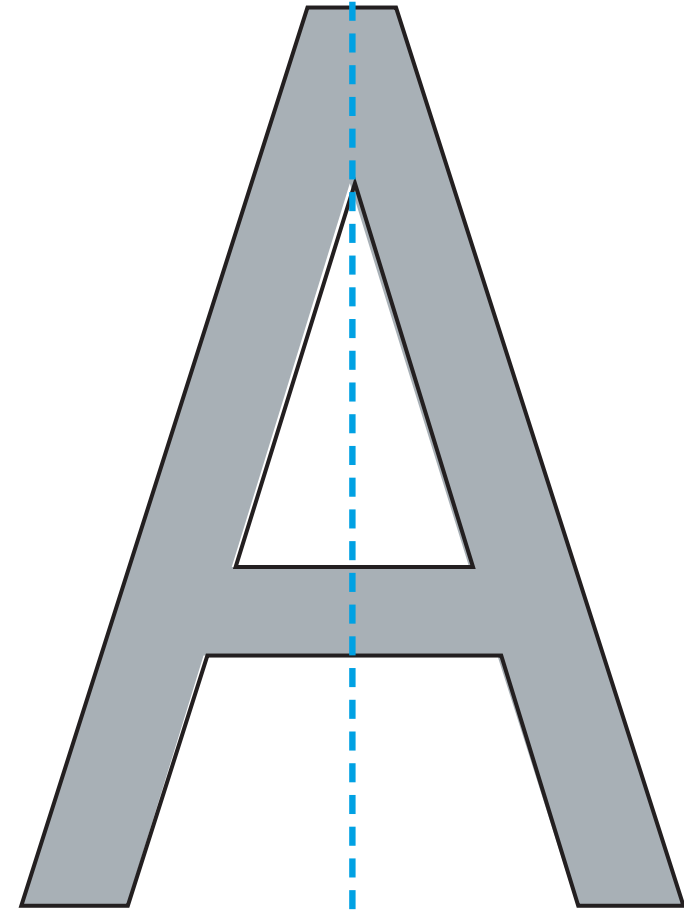
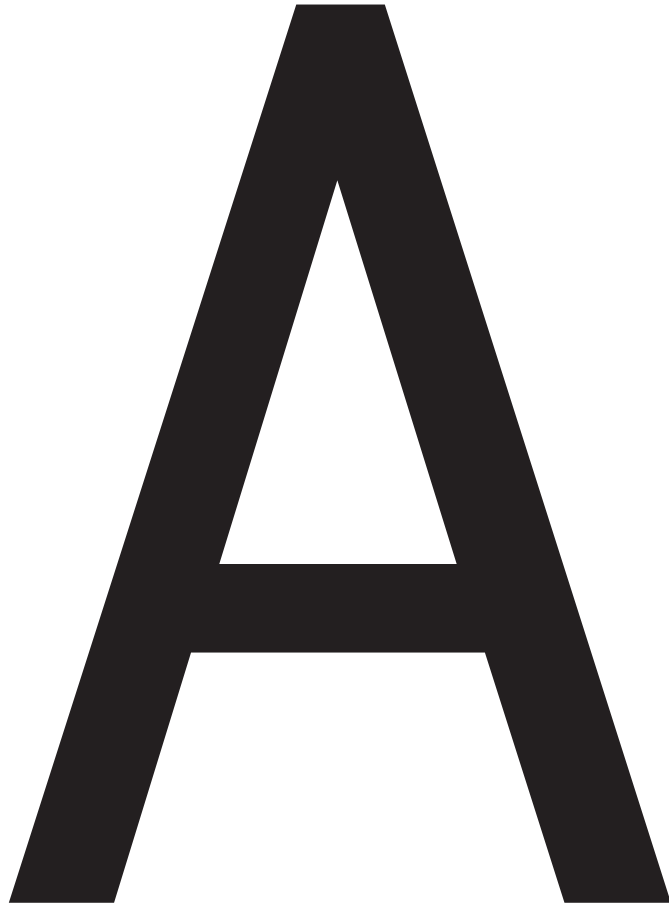

(outline) A ↑  
flipped horizontal

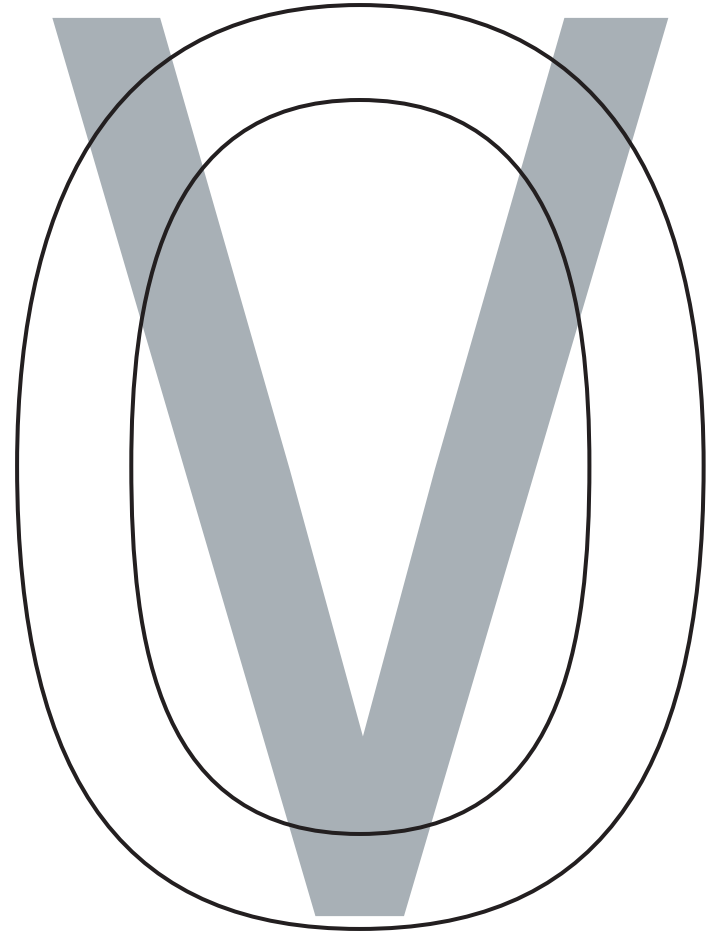



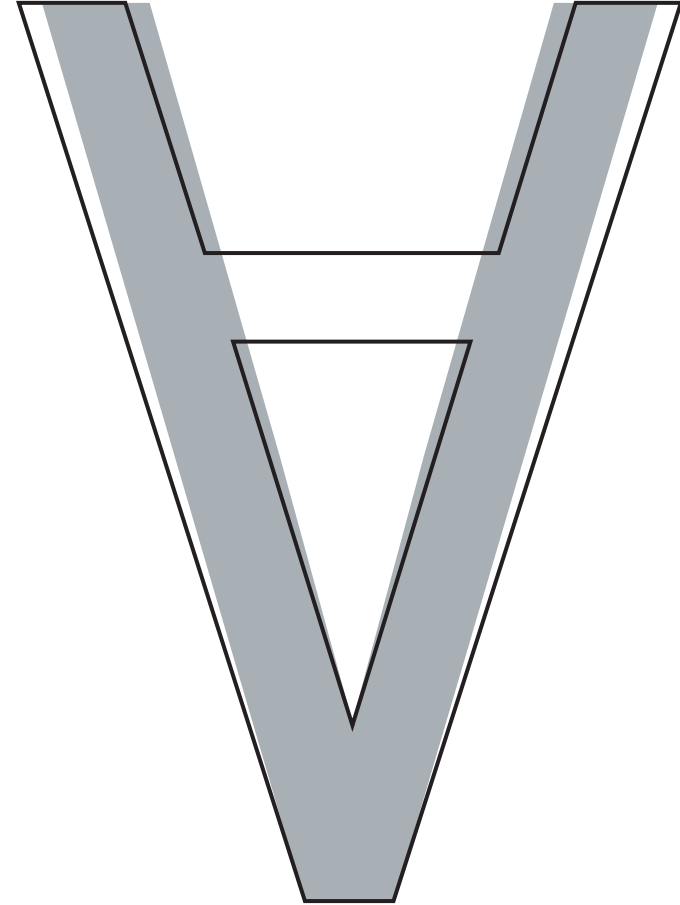

A rotated 180° ↑

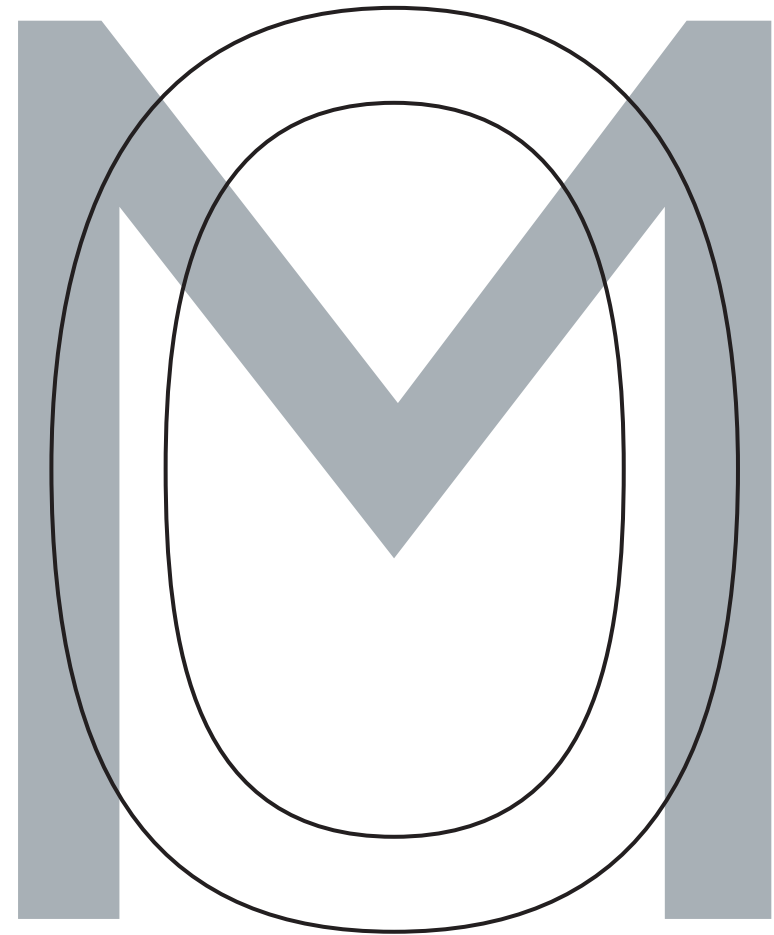

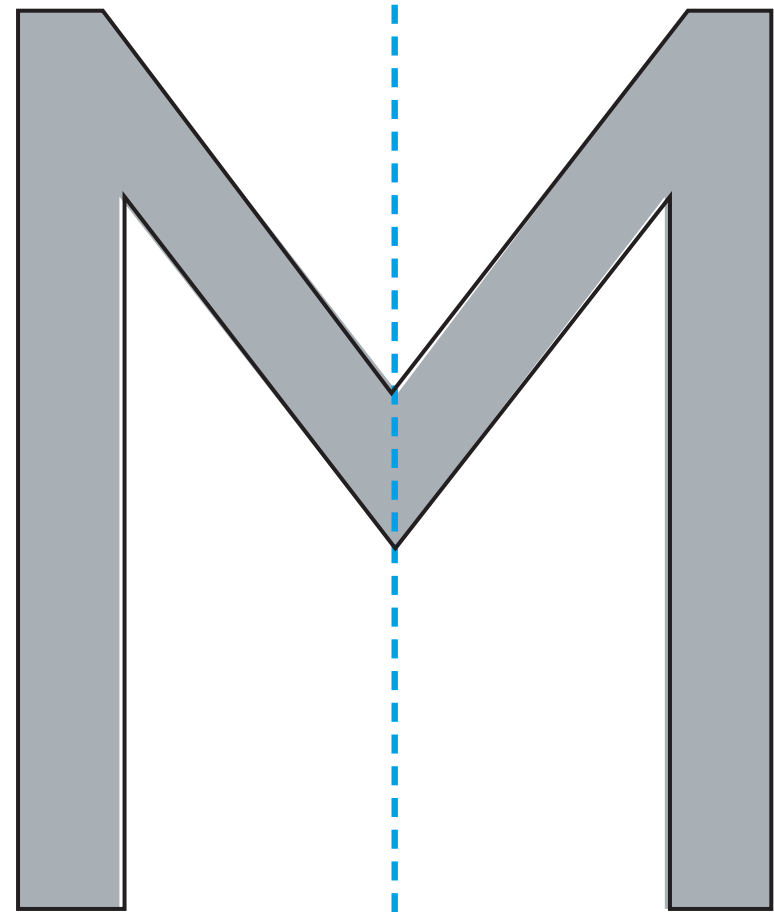

(outline) M ↑  
flipped horizontal

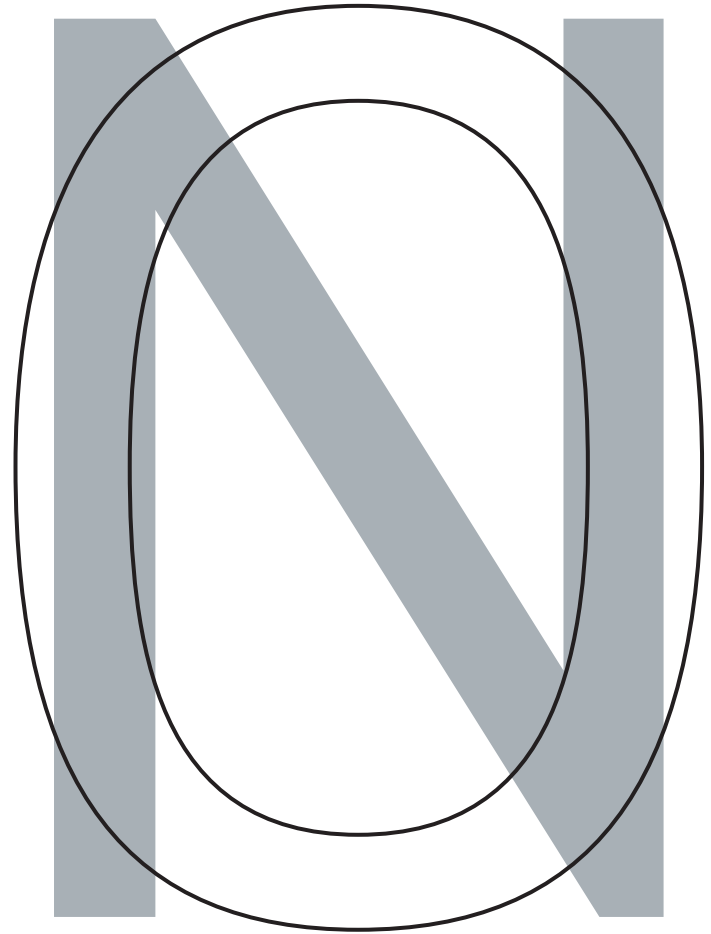

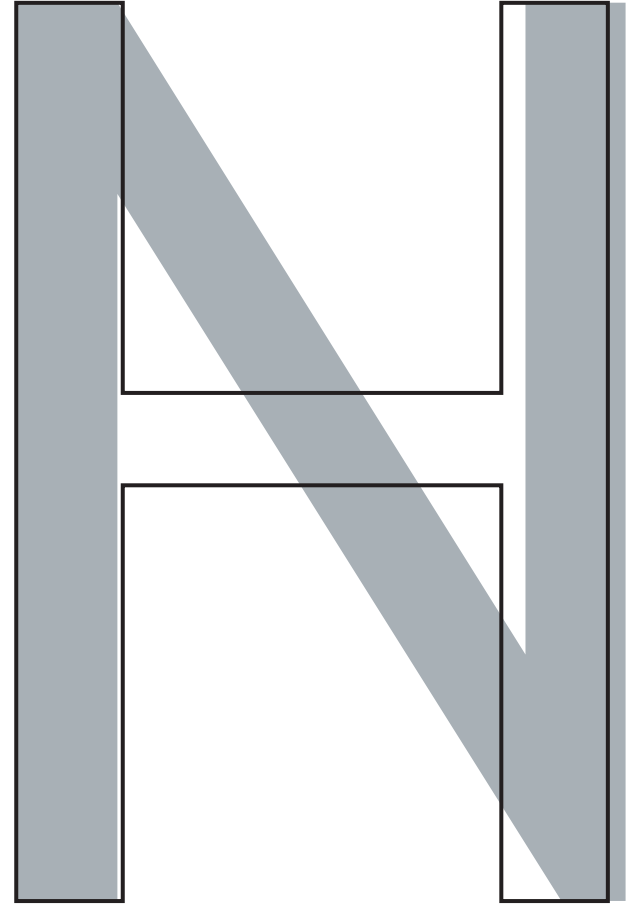
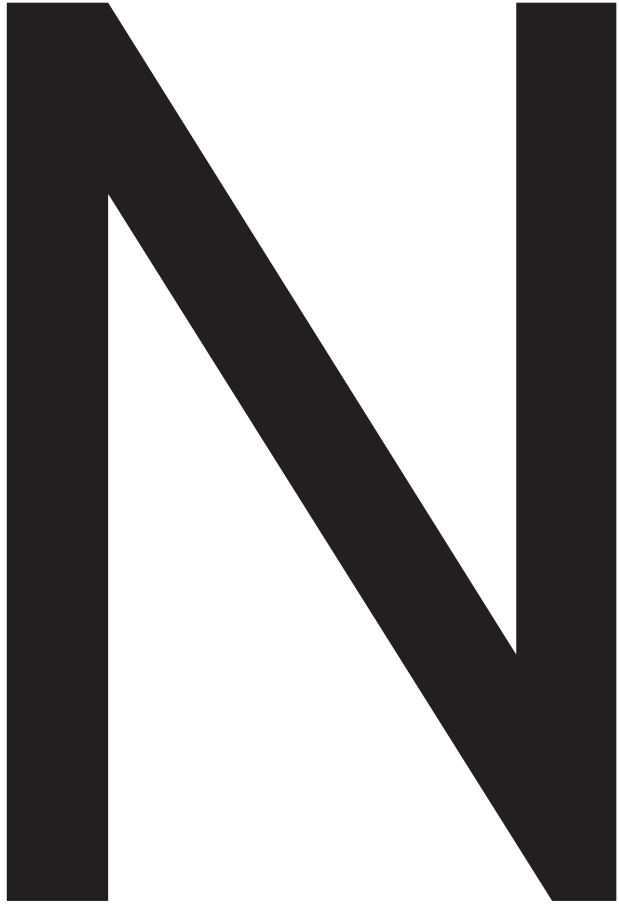

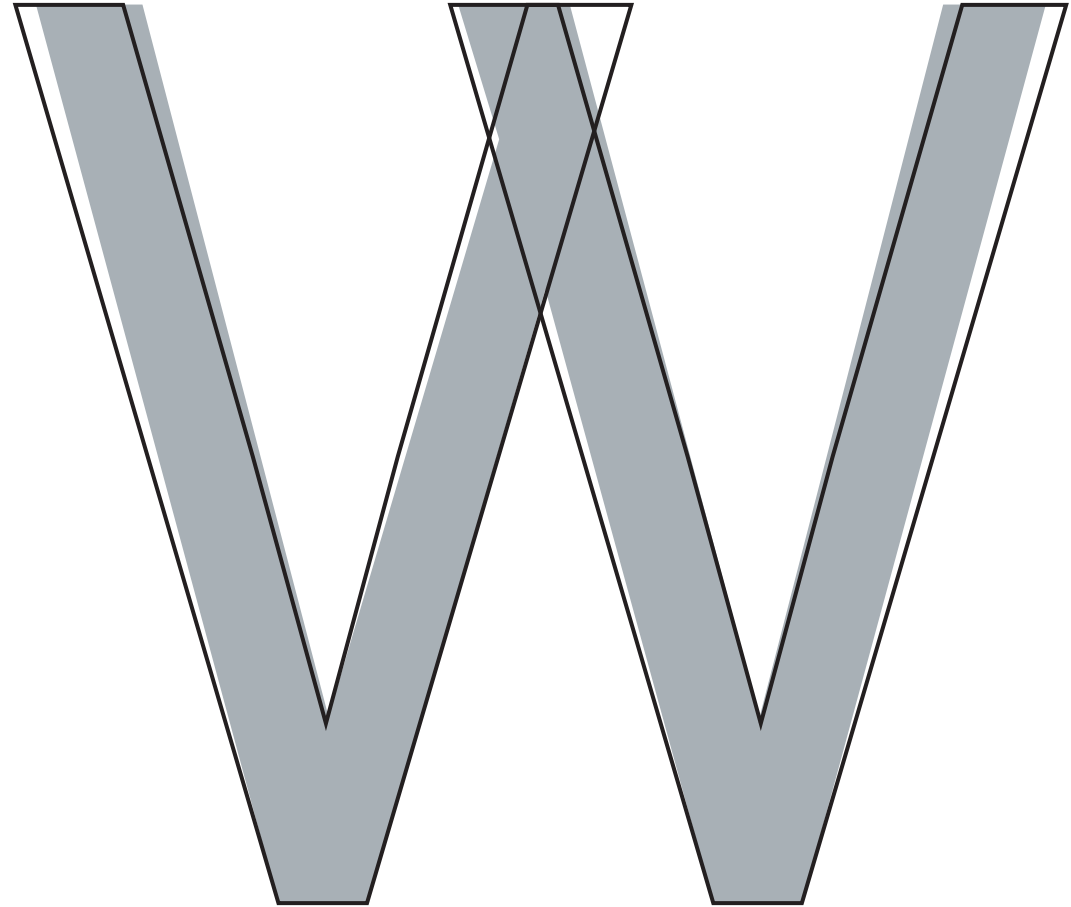

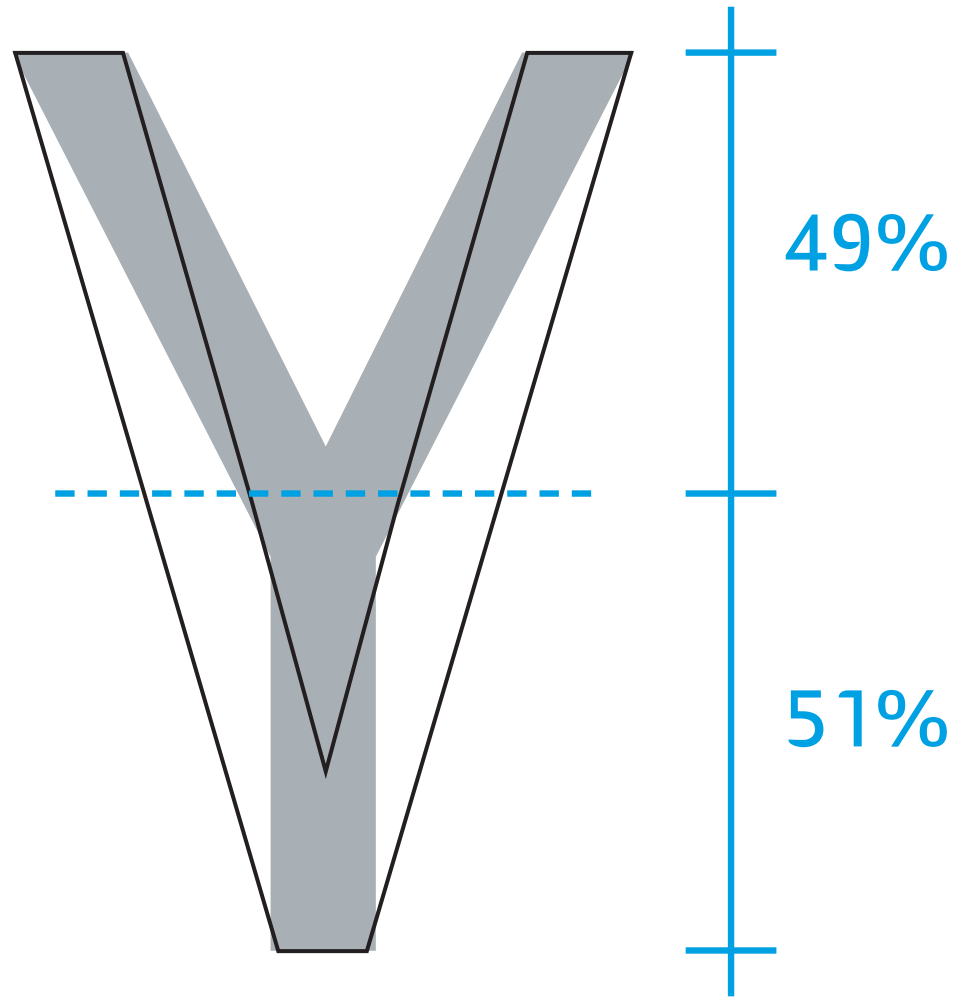

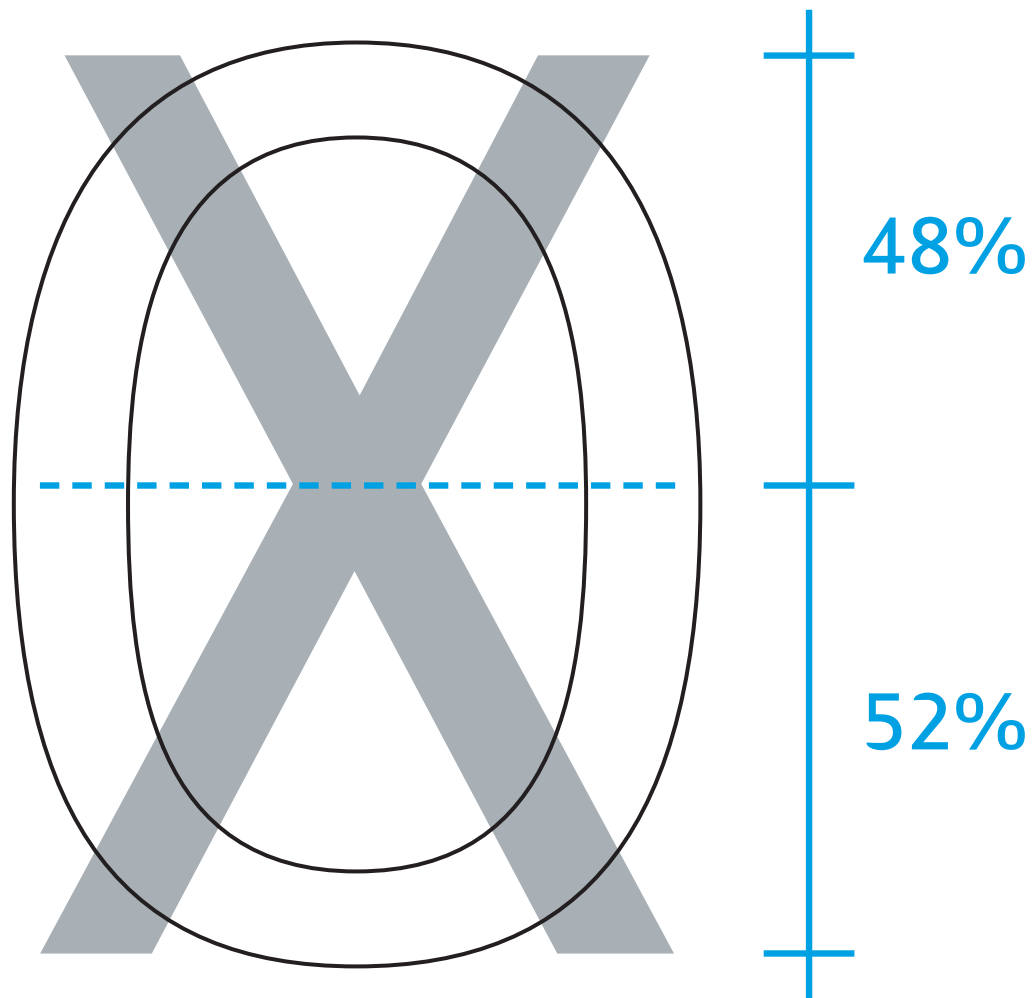



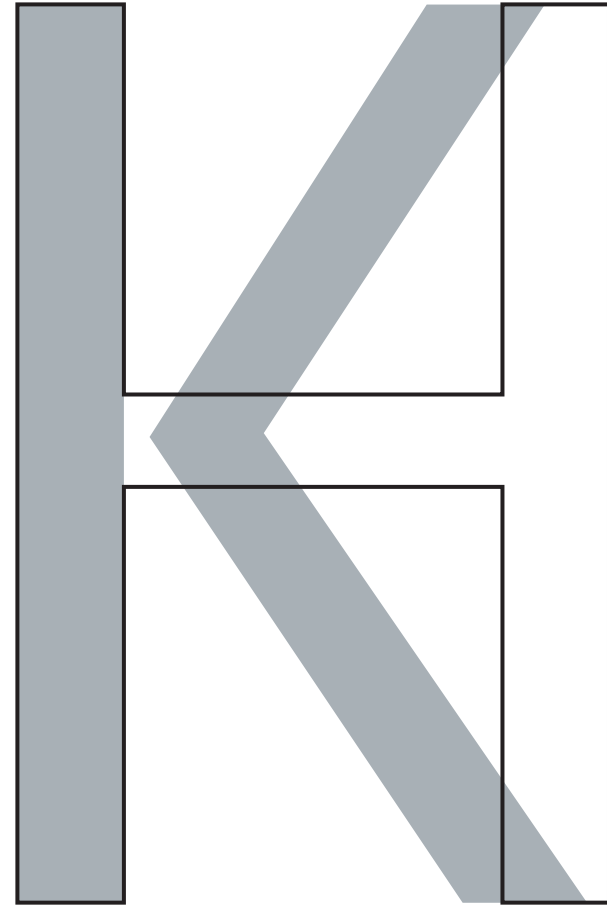

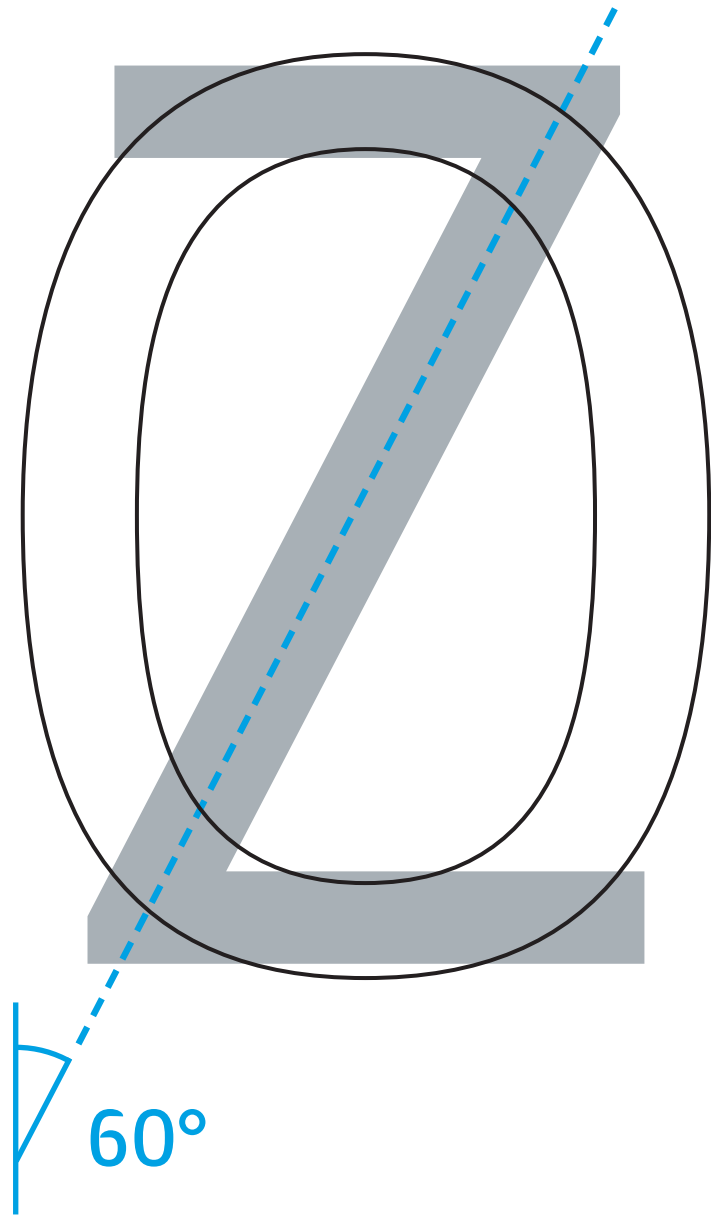

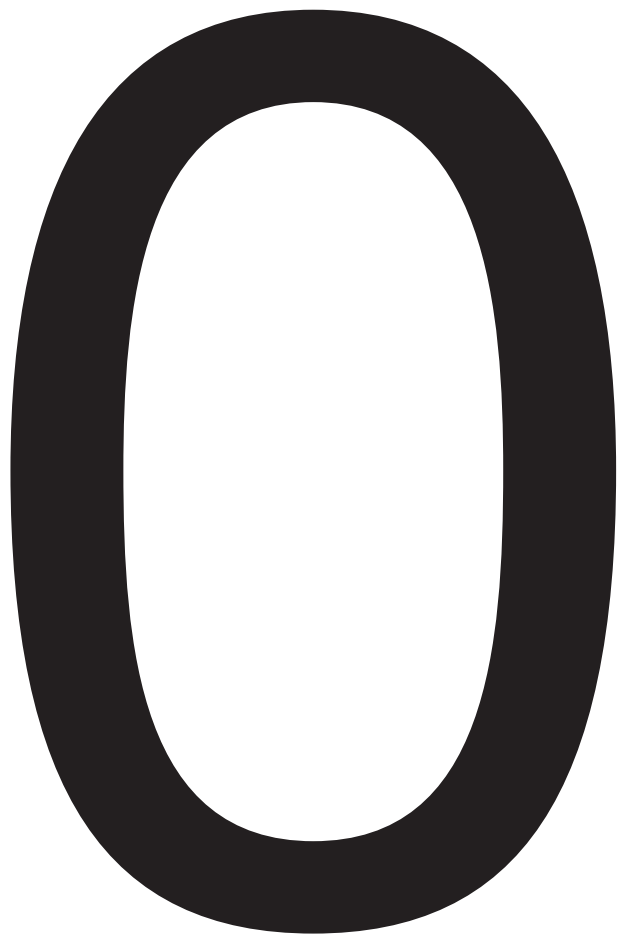

zero

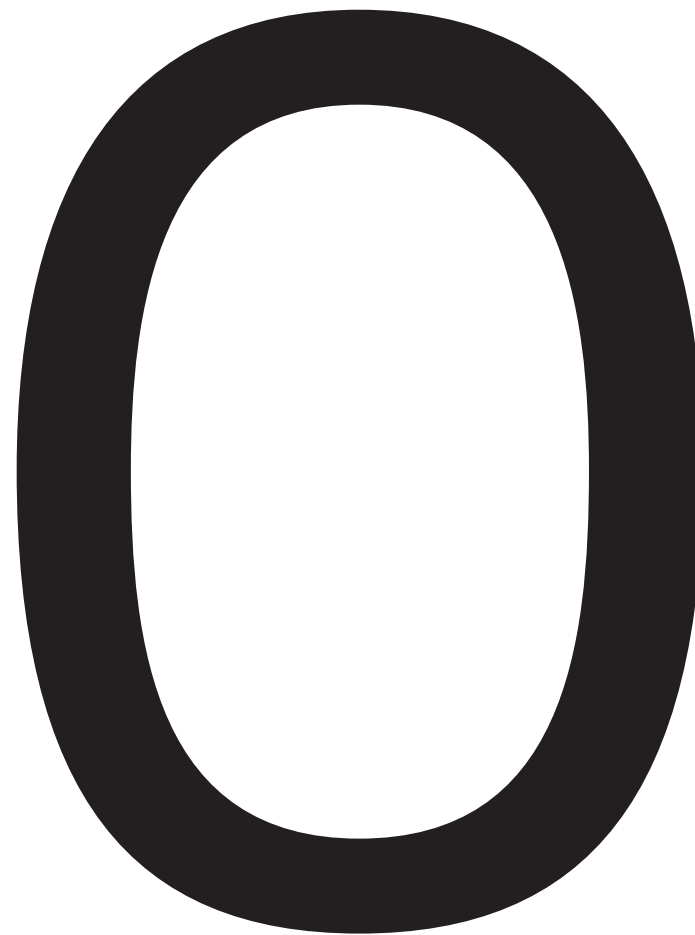

uppercase O

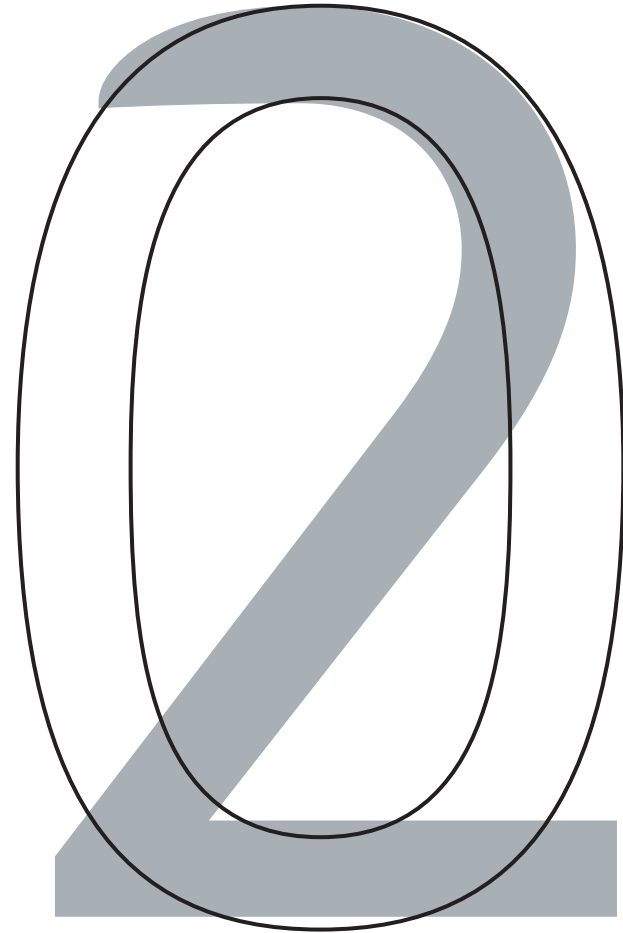

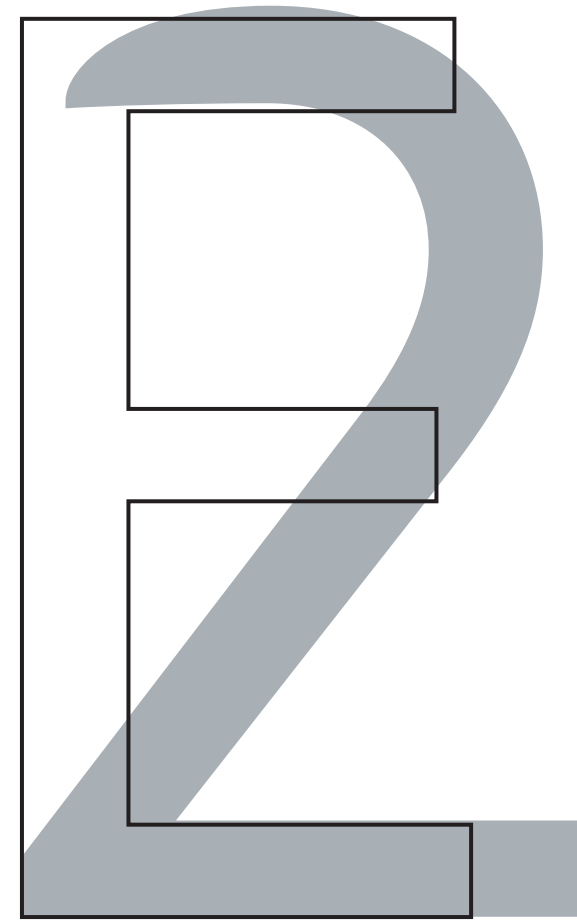

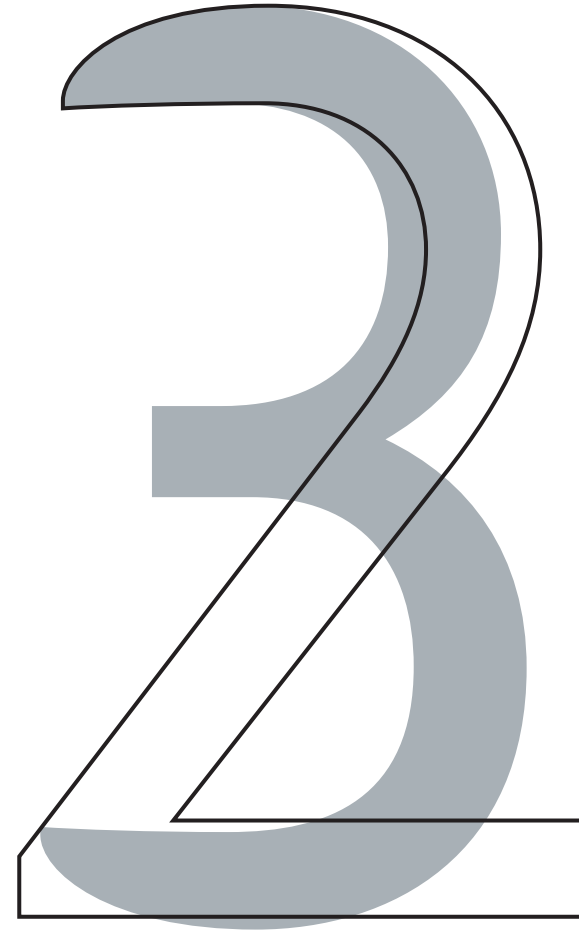
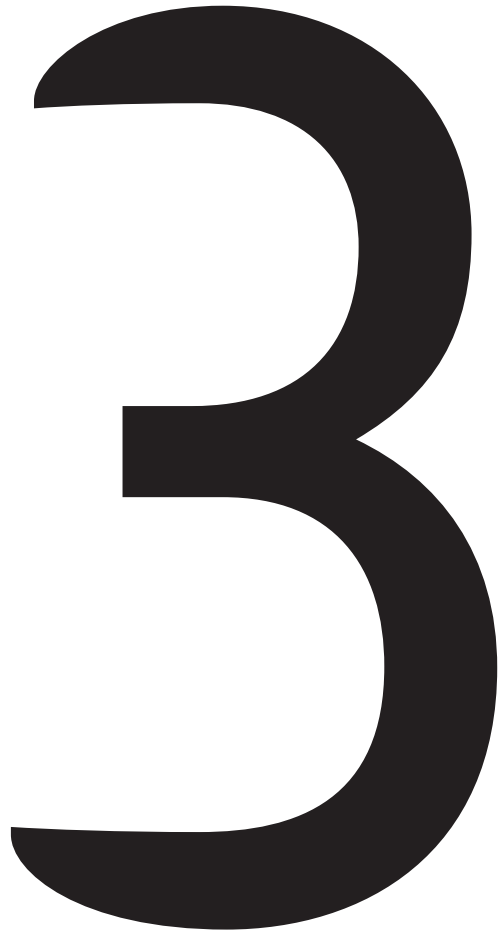

3

B

5

5



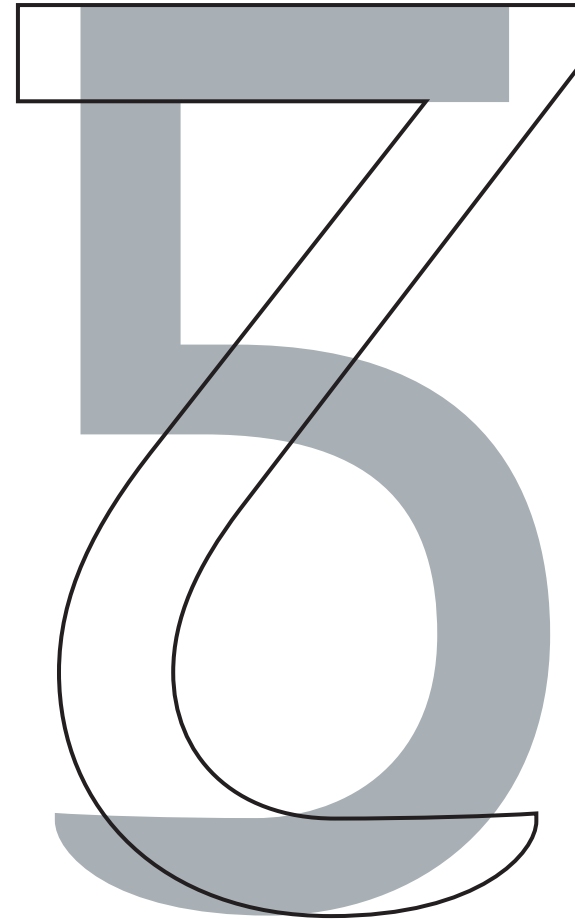
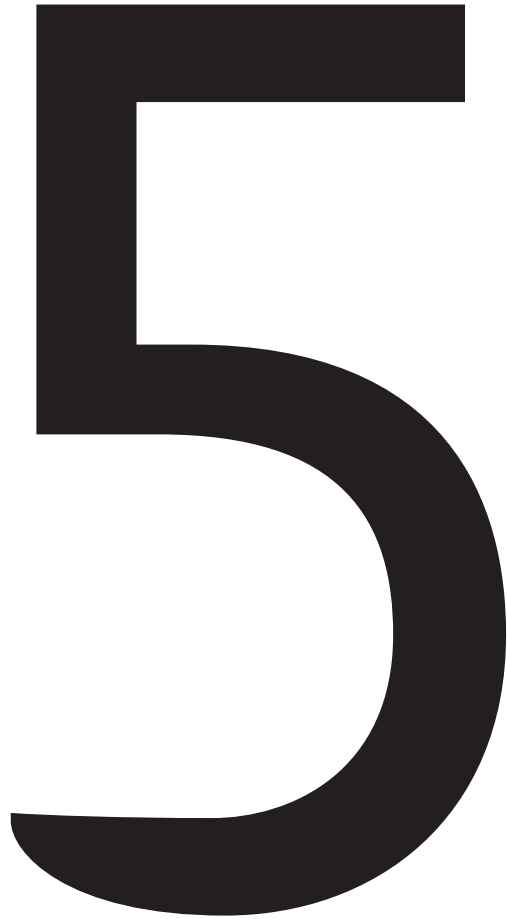

2 rotated 180° ↑

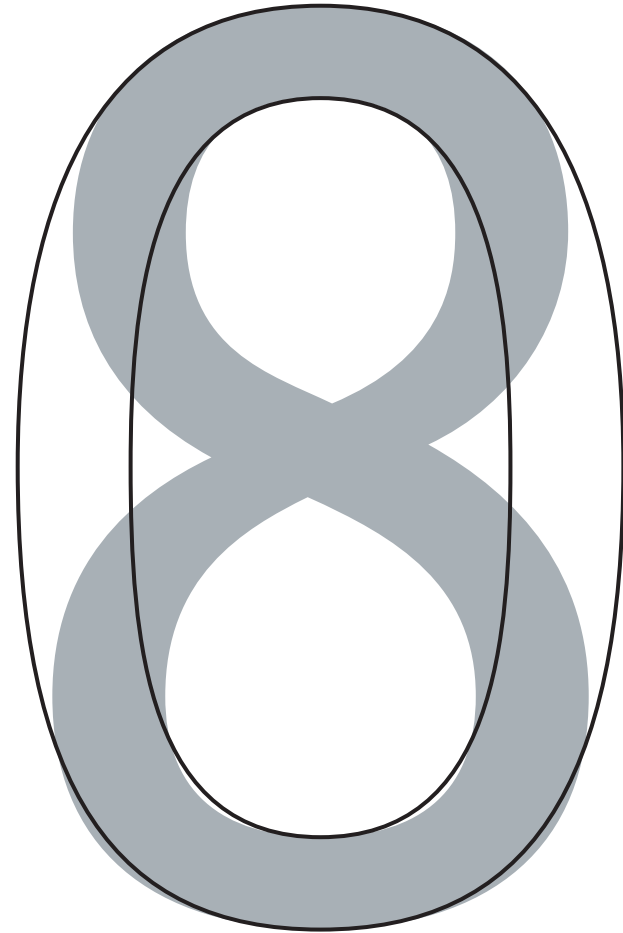
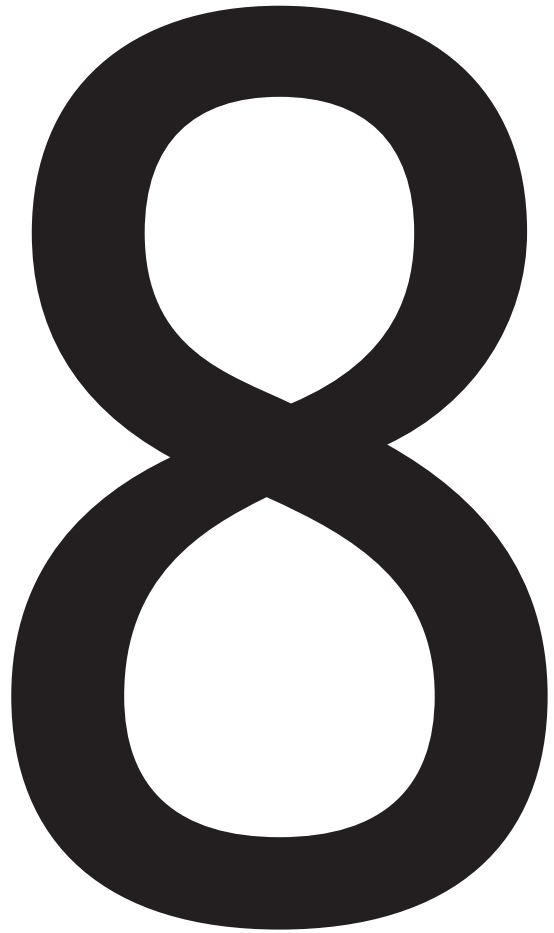

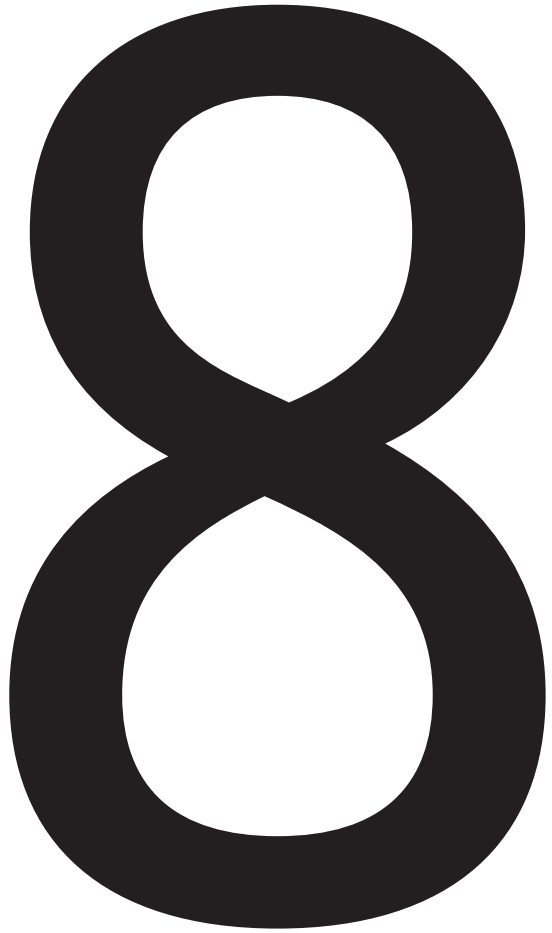

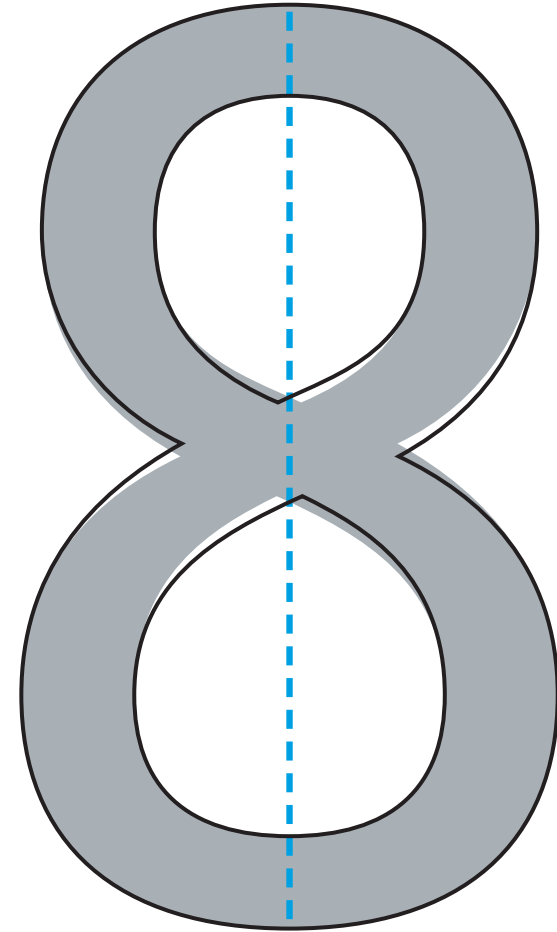
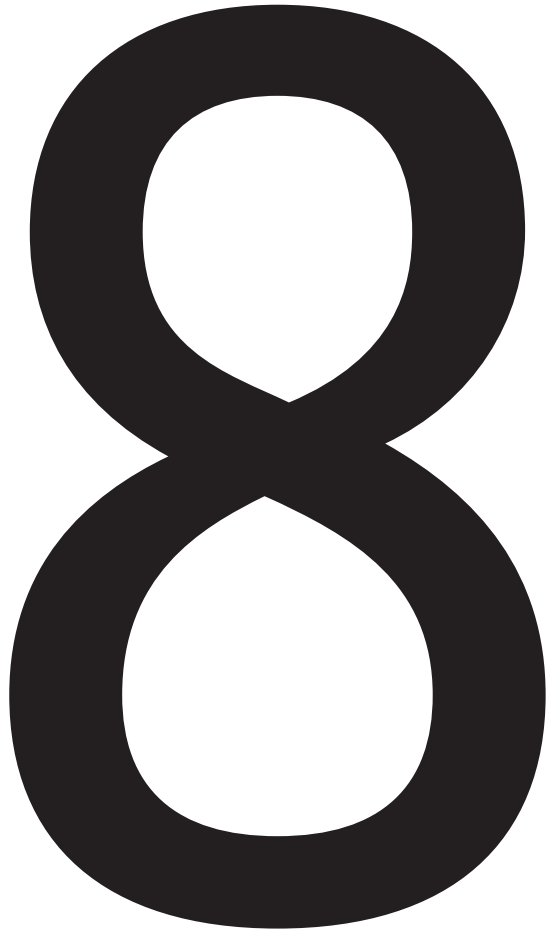

(outline) 8 ↑  
flipped horizontal

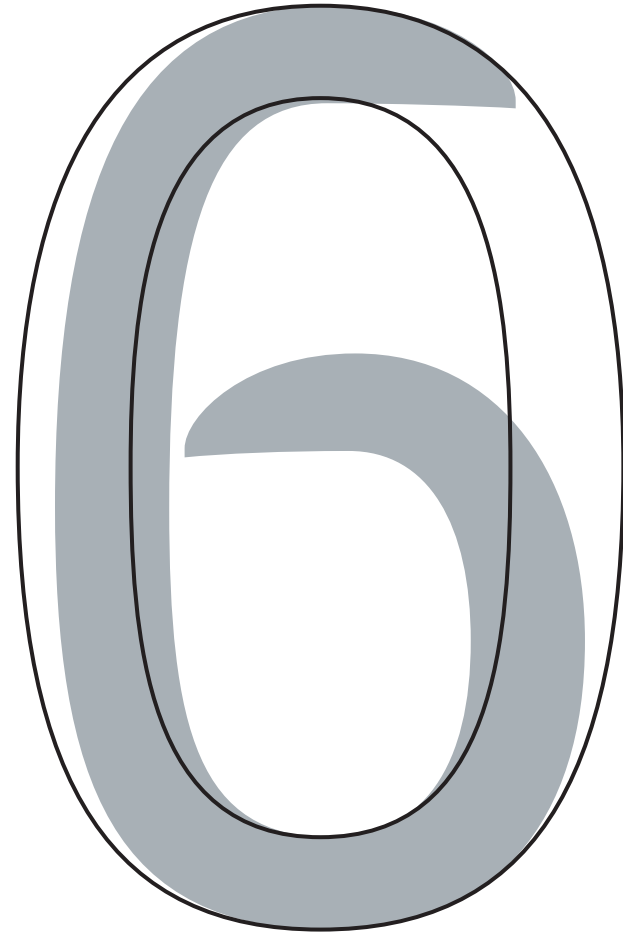
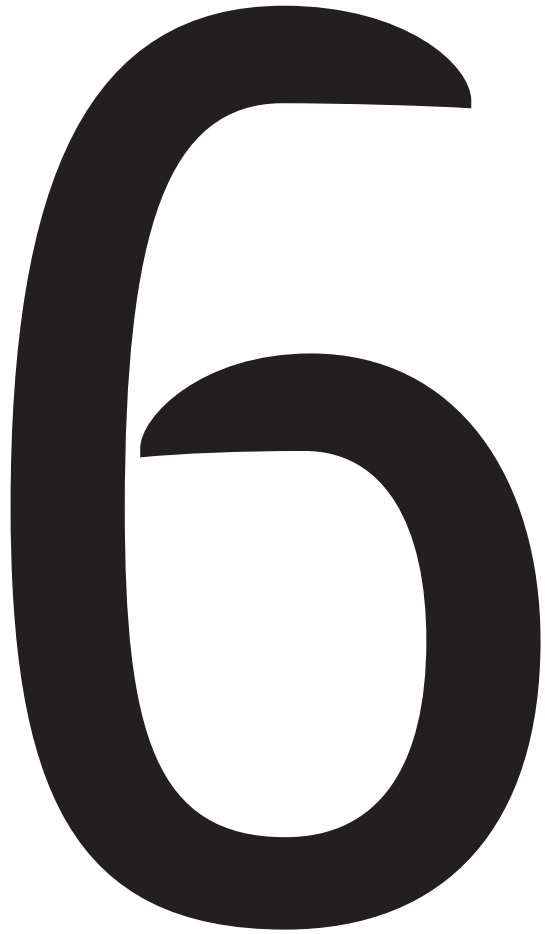

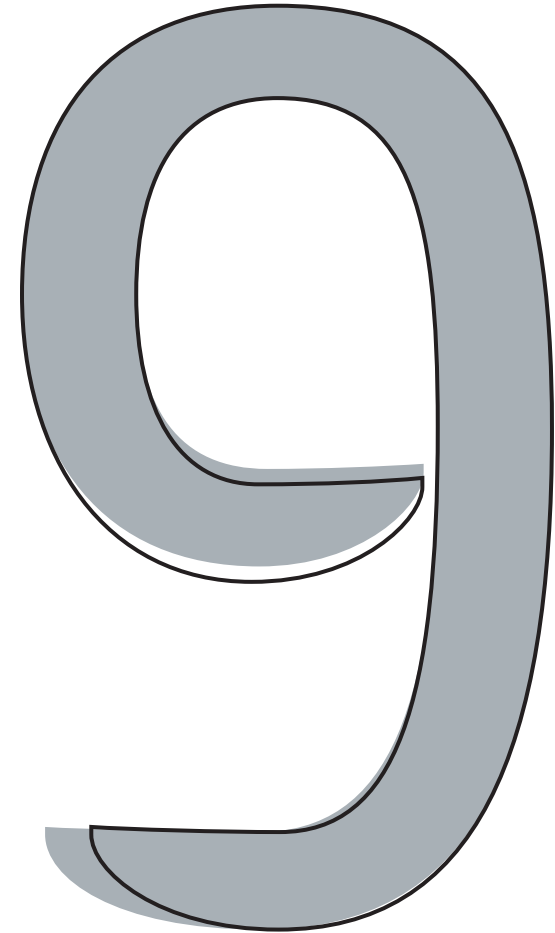

6 rotated 180° ↑

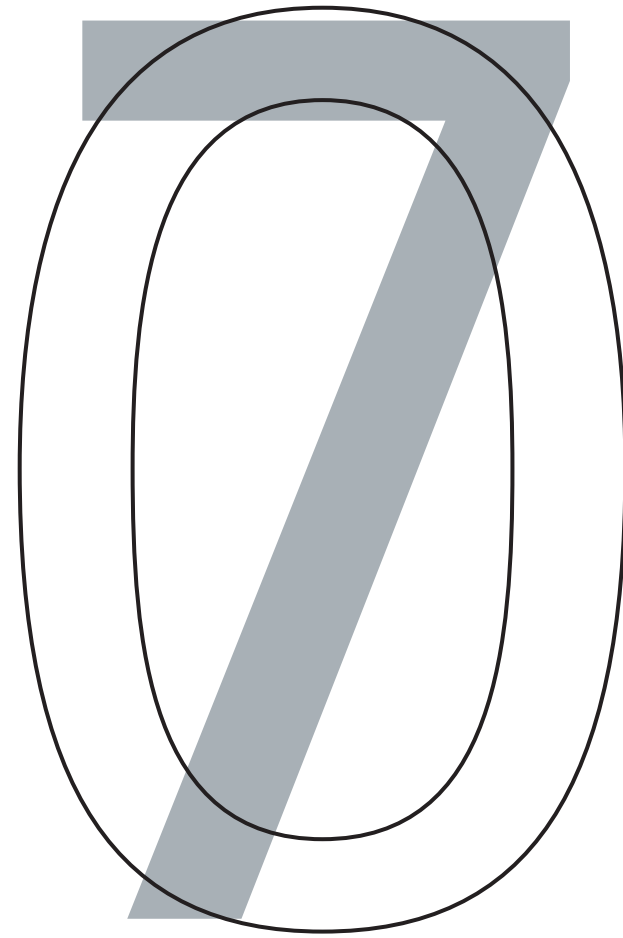
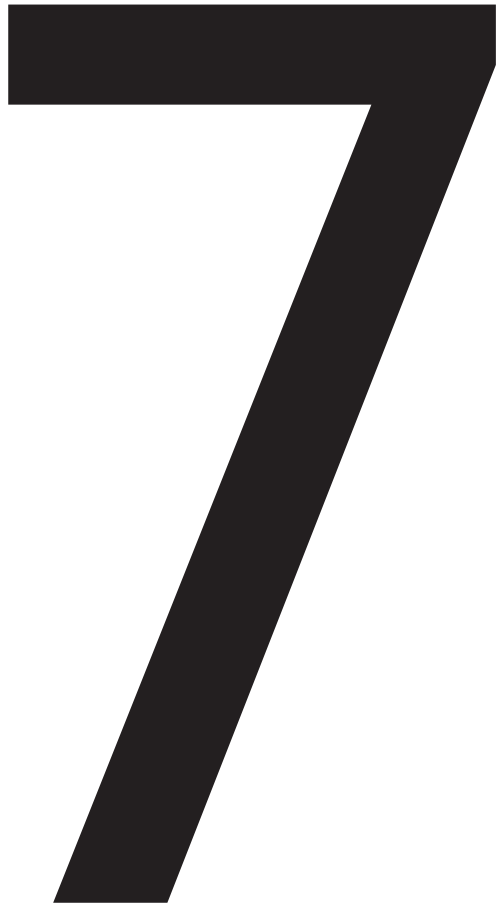

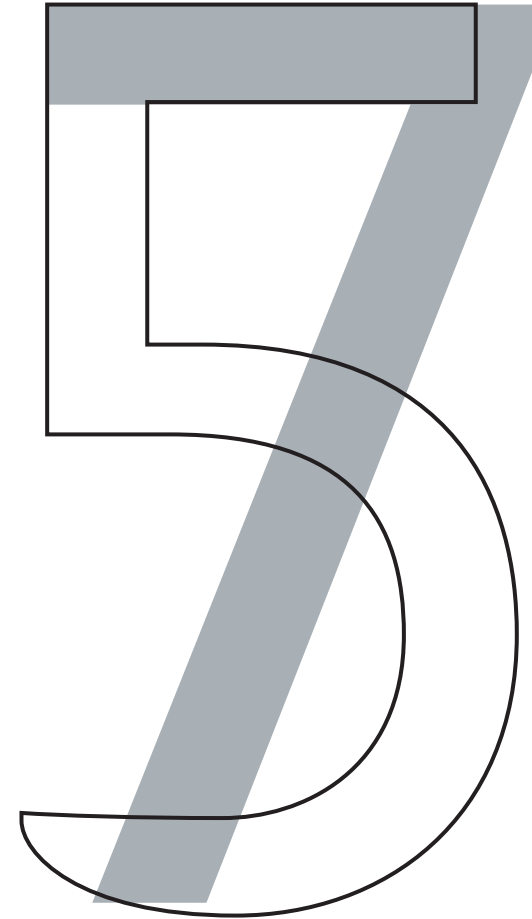
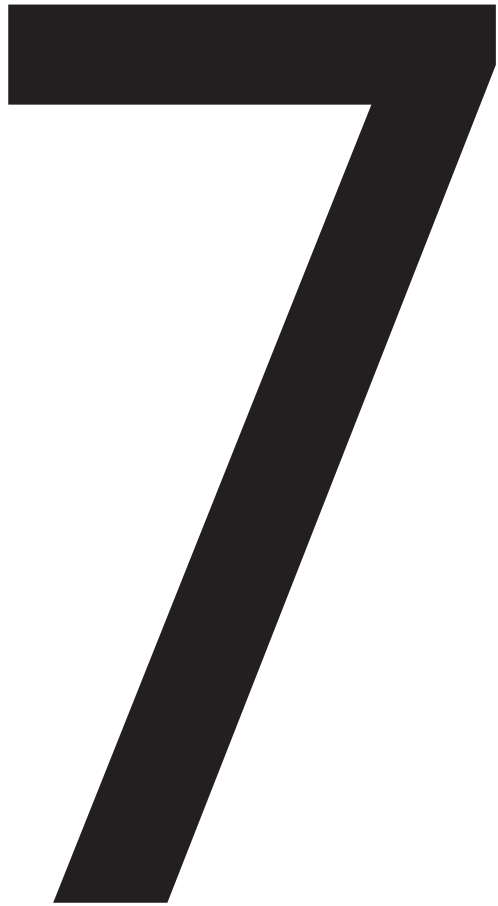



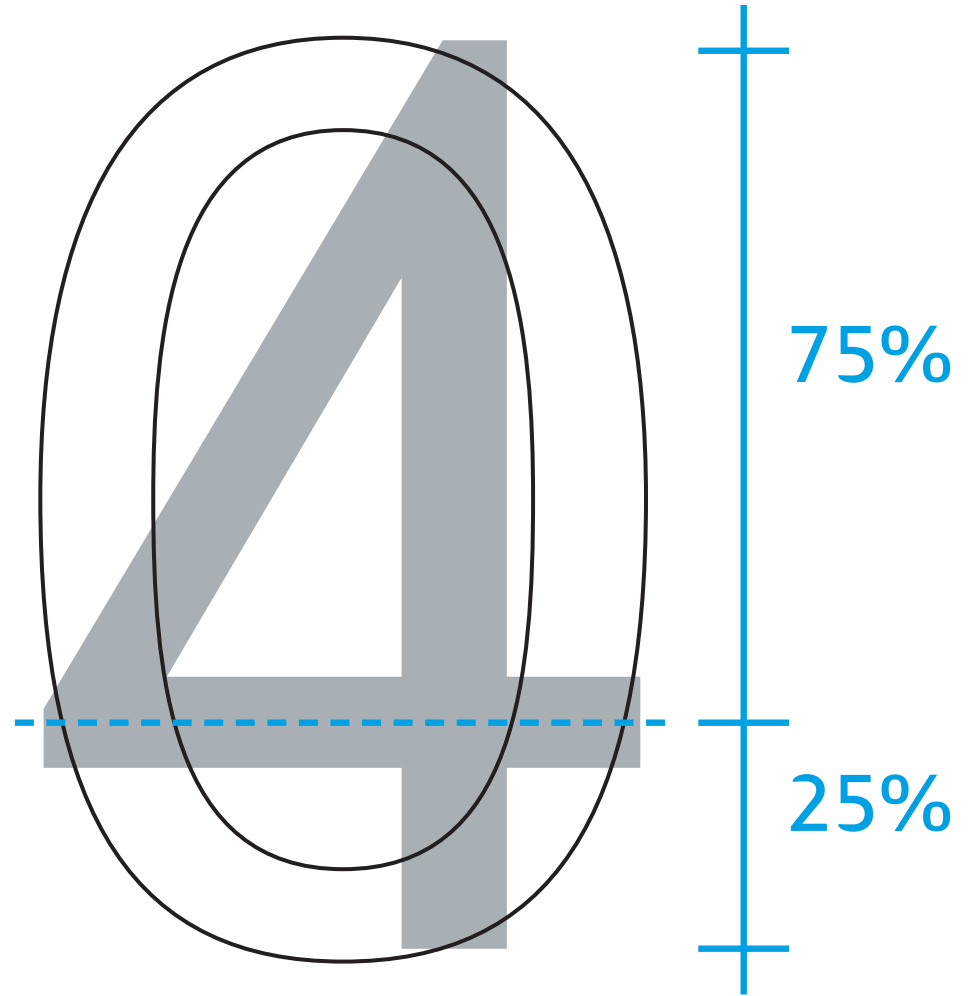

i rotated 180° →

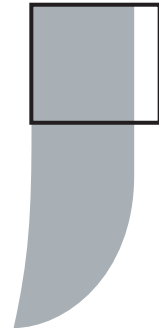
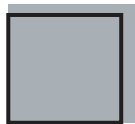
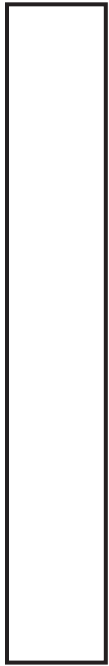

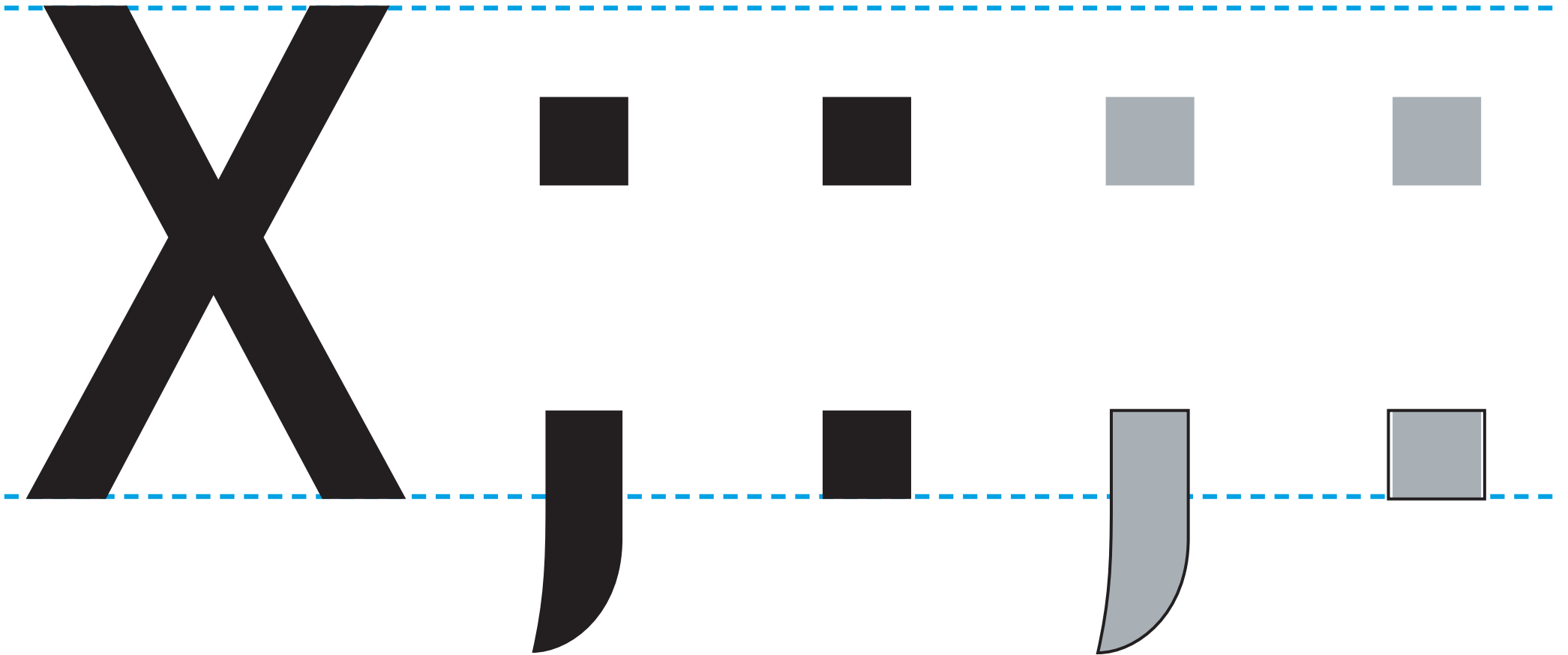



(outline) ↑  
period

(outline) ↑  
uppercase I

